

Guía de soluciones Kits Extensores HDMI



www.syscom.mx

Familia de productos

**Extensores
HDMI /
UTP**

**Extensores
HDMI
Inalámbricos**

**Extensores
HDMI sobre
Power line**

**Splitter
HDMI**

Kit HDMI

**Switch
Multiviewer
Video Wall
HDMI Switch
Matrix**

**Mini
Convertidor
Extensor,
Amplificador
Fibra óptica**

TT-372-PRO
TT-372-EDID
TT-383-PRO
TT-383-PRO-RX
TT-683
TT-683-RX
TT-672
TT-372-W
TT-383-W
TT-371-KVM
TT-383-VGA

TT-388-A
TT-388A-RX
TT-388-Dongle
TT-388-M
TT-388M-RX
TT-688
TT-688N

TT-380-PRO
TT-380-PRO-RX

TT-312-V2.0
TT-314-PRO
TT-318-PRO
TT-314-4K-
HDbiT-TX

TT-714-PRO
TT-718-PRO

TT-401-MS
TT-314-VW
TT-501-V2.0
TT-414
TT-818
TT-383-MATRIX
TT-383-MATRIX-RX
TT-683-MATRIX
TT-683-MATRIX-RX
HDMC01

TT-350-MINI
TT-168-4K
TT-378A-4K
TT-7505



Extensores HDMI por UTP

Modelos	Productos	Características
TT-372-PRO	HDMI Extensor	Full 1080P, use Cat6 to 60M, con IR & Loop-out
TT-372-EDID	HDMI Extensor	Full 1080P, use Cat6 to 60M, con IR & Loop-out
TT-383-PRO	HDMI Extensor	Full 1080P, use Cat5/6 to 120M/150M, con IR & Loop-out
TT-383-PRO-RX	HDMI Receptor	Full 1080P , use Cat5/6 to 120M/150M, con IR
TT-683	4K Extensor	4K@30Hz, use Cat5/6 to 120M, con IR
TT-683-RX	4K Receptor	4K@30Hz, use Cat5/6 to 120M, con IR
TT-672	4K Extensor	4K@30Hz, use Cat6 to 60M, 4K@60Hz a 30M, con IR
TT-372-W	HDMI Extensor	Full 1080P, use Cat6 to 50M, con IR Placa de pared
TT-383-W	HDMI Extensor	Full 1080P, use Cat6 to 150M, con IR Placa de pared
TT-371-KVM	KVM Extender	Full 1080P use Cat6 to 60M, con IR & Loop-out y KVM
TT-383-VGA	VGA Extender	Full 1080P over Cat5/6 a 120M/150M

Características

- HDMI por CAT6 a **60M**
- Bucle de salida HDMI en TX para visualización local
- Soporta señal AV sin compresión y transmisión sin pérdidas
- Ajuste automático para que coincida con la longitud del cable de 1-60 m de CAT6
- Plug & Play
- Control remoto de infrarrojos latencia cero

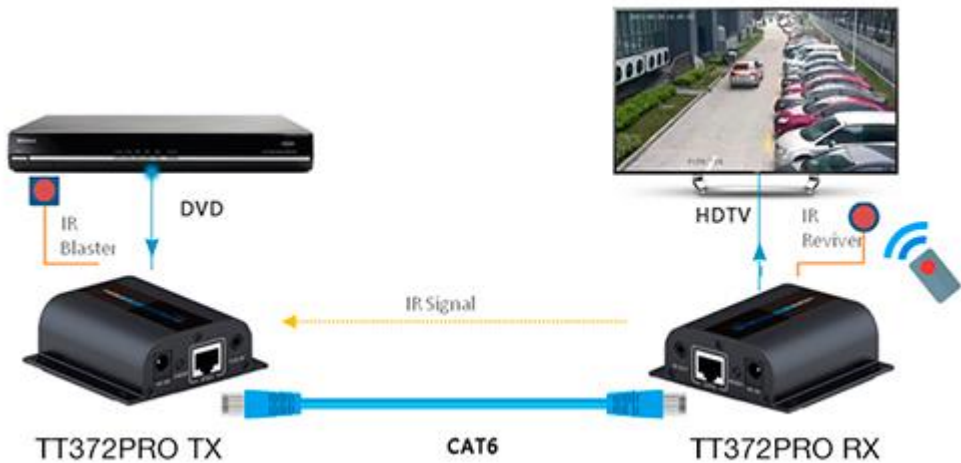

TT-372-PRO

HDMI **1080P** CAT6 a 60M, con IR y HDMI Loop-out



Bucle de **salida HDMI** en TX para visualización local



TT-372-EDID

HDMI sobre CAT6 a **60M**, con IR y HDMI Loop-out



- HDMI sobre solo CAT6 a **60M**
- Bucle de salida HDMI en TX para visualización local
- Soporta señal AV sin compresión y transmisión sin pérdidas
- Ajuste automático para que coincida con la longitud del cable de 1-60M de CAT6
- Solo una fuente de alimentación en el lado del transmisor
- Control remoto de infrarrojos
- latencia cero

Connection

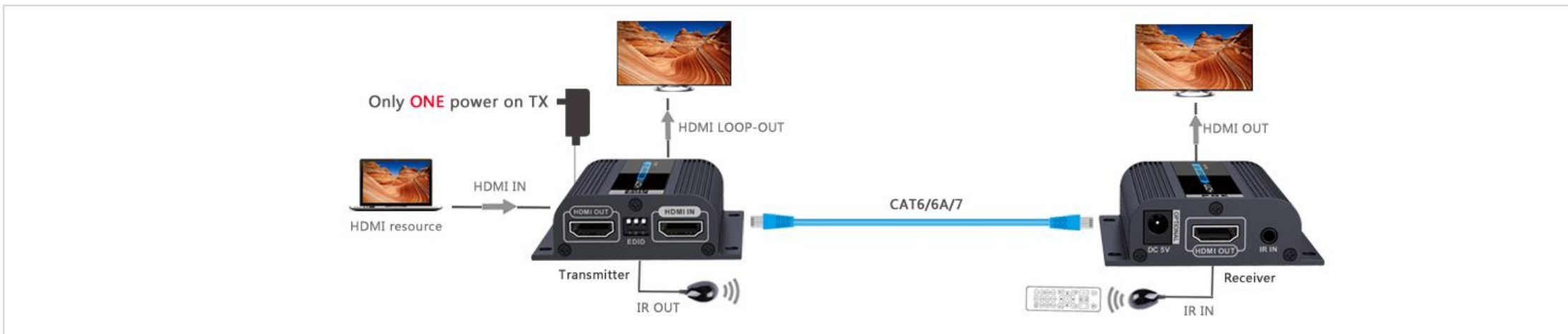

Características

- HDMI por CAT5e/6 to 120M/**150M**
- HDMI Loop-Out
- Control IR remoto
- Función en **cascada** a través de router
- Conexión **1 a muchos**

TT-383-PRO

HDMI 1080 P Cat6 **150M** con IR, HDMI **Loop-Out**



Conexión por Cascada

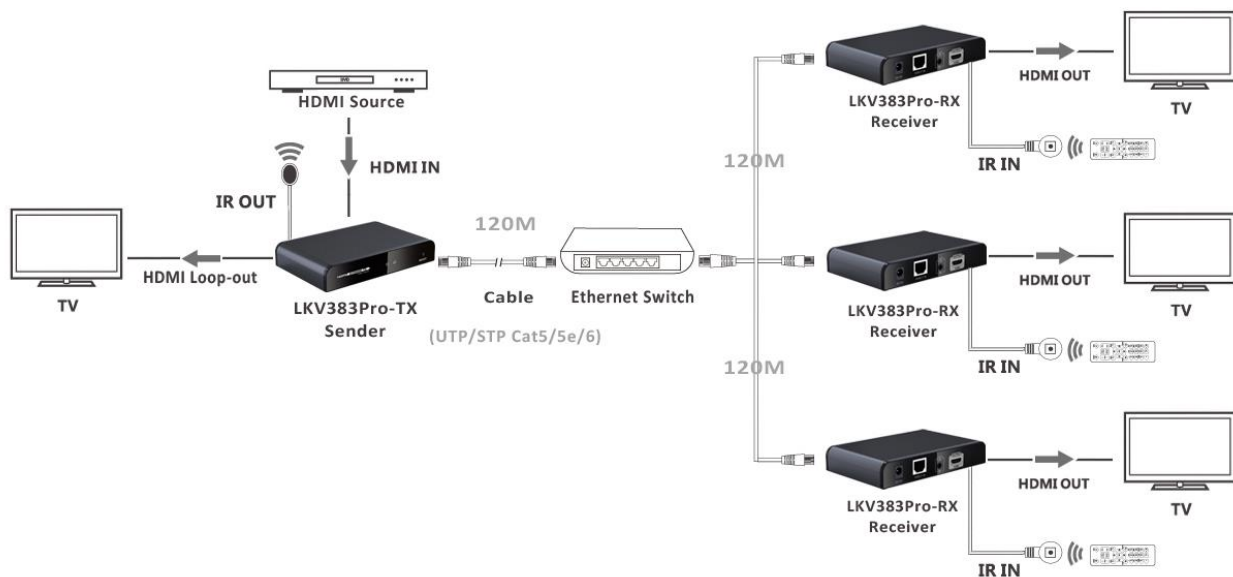
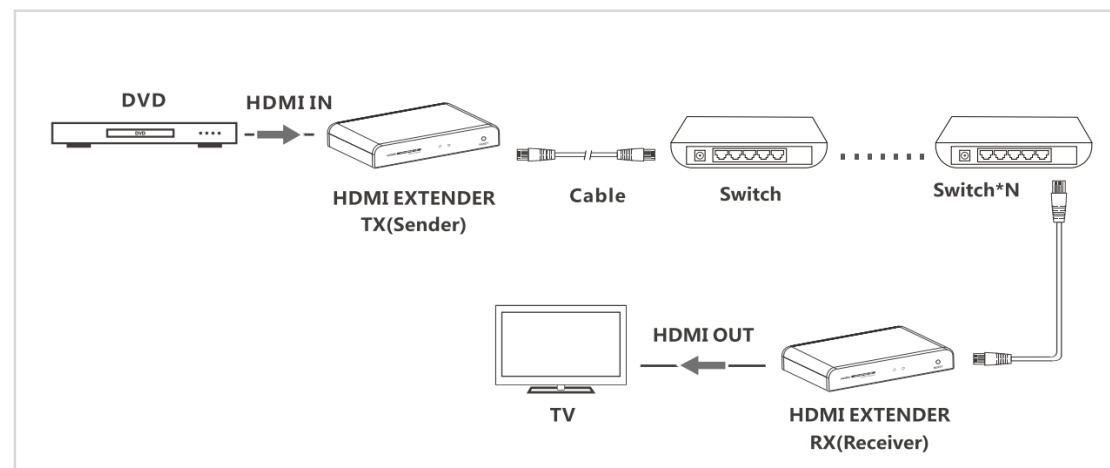

TT-672

HDMI2.0 4K x 2K Extender CAT Cable



Zero latency



4Kx2K@30/60Hz
ultra HD



Over CAT6
/6A/7



20-60KHz
IR passback

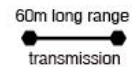

60m long range
transmission

- HDMI2.0
- HDCP2.2
- **4K x 2K @ 30Hz** use Cat6 para 60 m
- **4K x 2K @ 60Hz** use Cat6 to 30m
- Control remoto por IR

Conexión

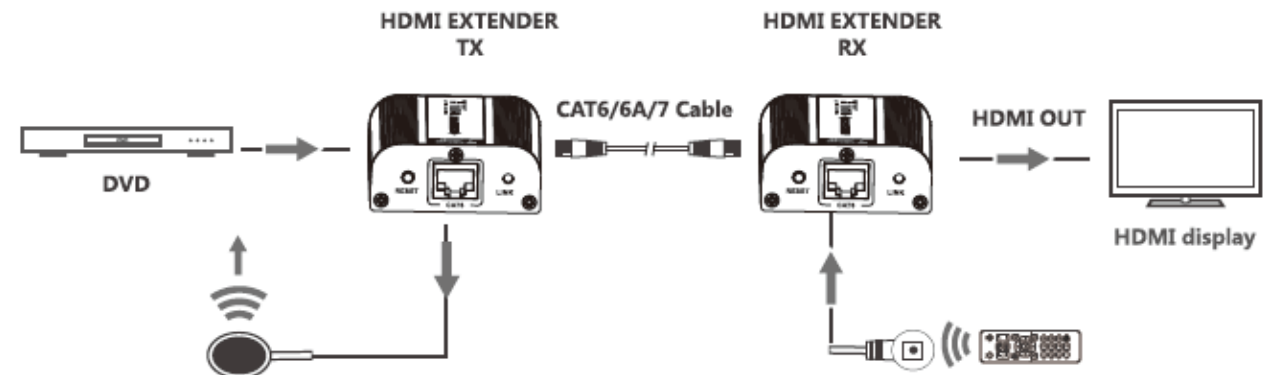

TT-683

Extensor por UTP Cable **4K x 2K**



- **4K x 2K** por CAT5e/6 @ 120M/150M
- Control IR
- Conexión en **Cascada**
- Conexión **1 a muchos**

Application

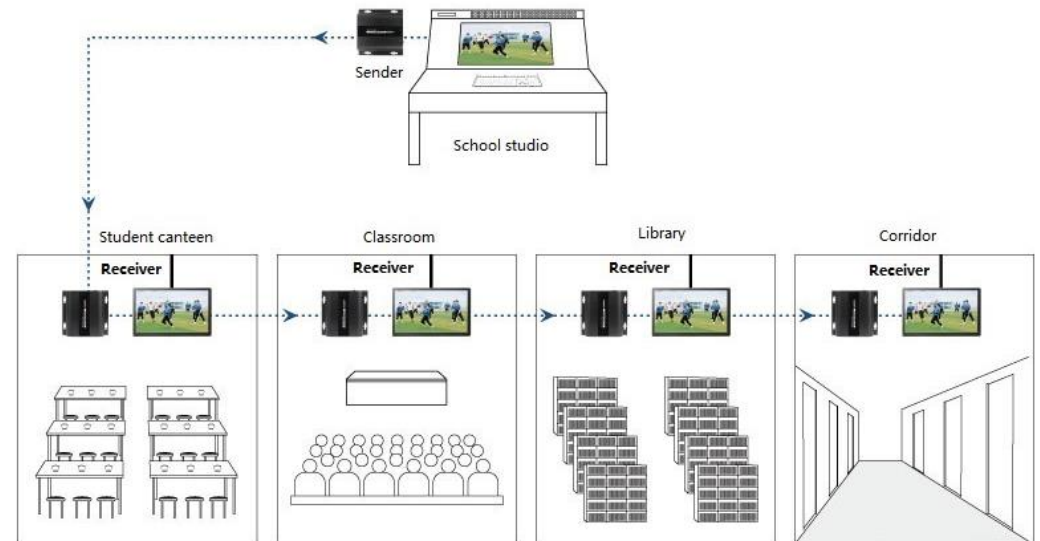
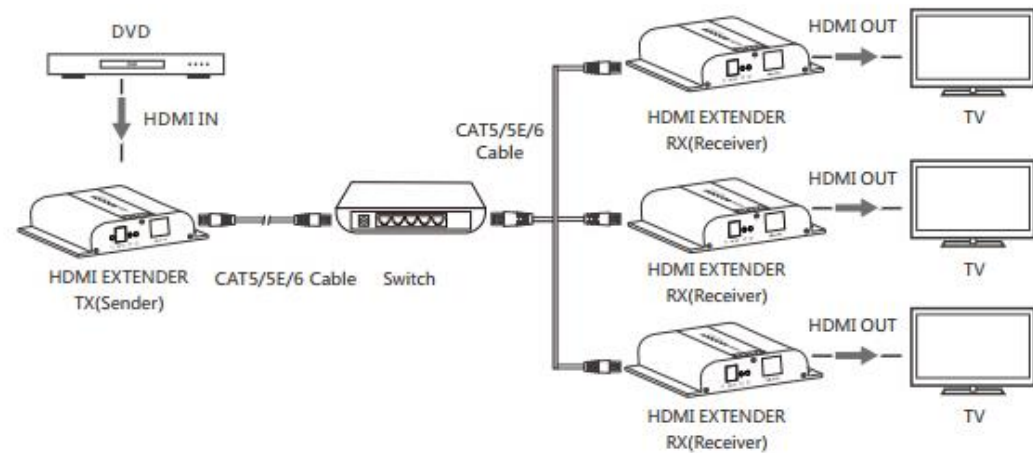

Extensores HDMI a través de placas de pared

Modelos	Productos	Características
TT-372-W	Extensor HDMI	Full 1080P, use Cat6 a 60 m , con IR
TT-383-W	Extender HDMI	Full 1080P, use Cat6 a 120 m, con IR

TT-383-W

Extensores por UTP en Placas de pared



- HDMI use CAT5/5e/6 @ **120M/150M**
- Placas de pared
- Conexión 1 a muchos
- IR
- Soporta voltaje de entrada de 100-240Vca

■ Conexión 1 a 1

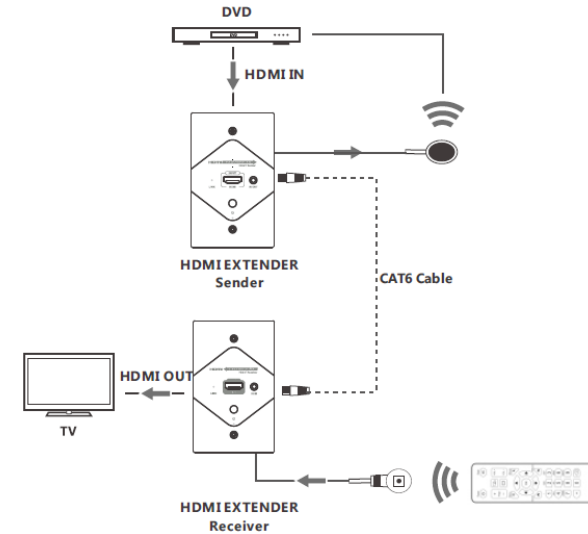

■ Conexión 1 a muchos

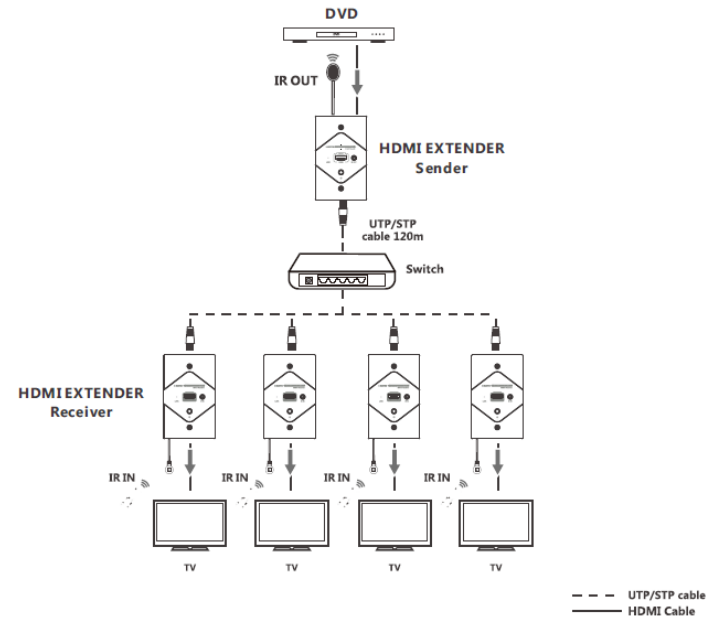

TT-372-W

Extensores por UTP en Placas de pared



TT372W

- HDMI use CAT6 @ **50 m**
- Placas de pared
- IR
- Soporta voltaje de 100-240Vca

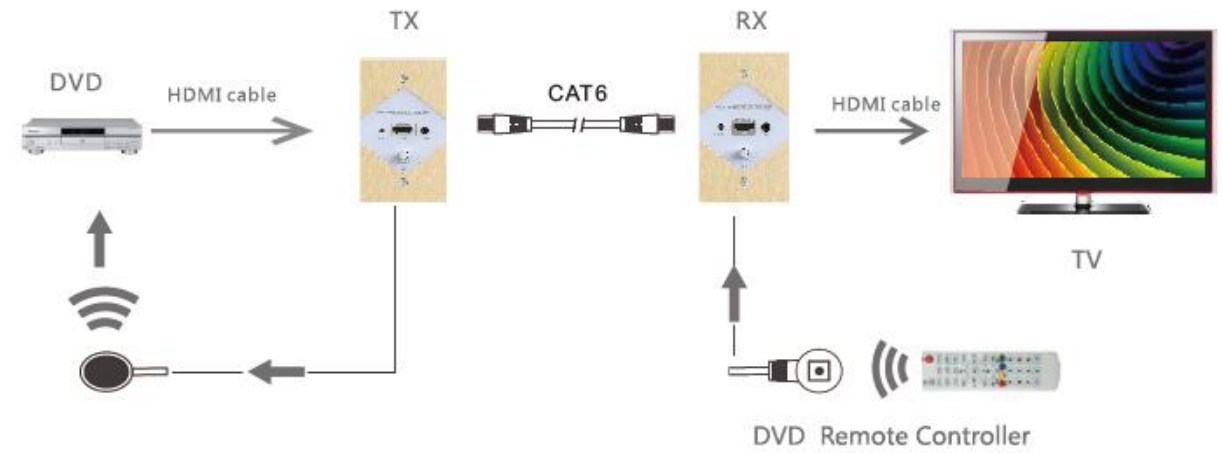

TT-371-KVM

HDMI Extender USB2.0



Real time



60M/CAT5



KVM



1080P HD



Compliant CAT5/5e/6



Point to point configuration

- **1080P** por CAT6 to **60M**
- Con loop de salida
- Puerto USB2.0 para KVM (Keyboard Video Mouse)
- Tiempo Real sin latencia

Conexión :

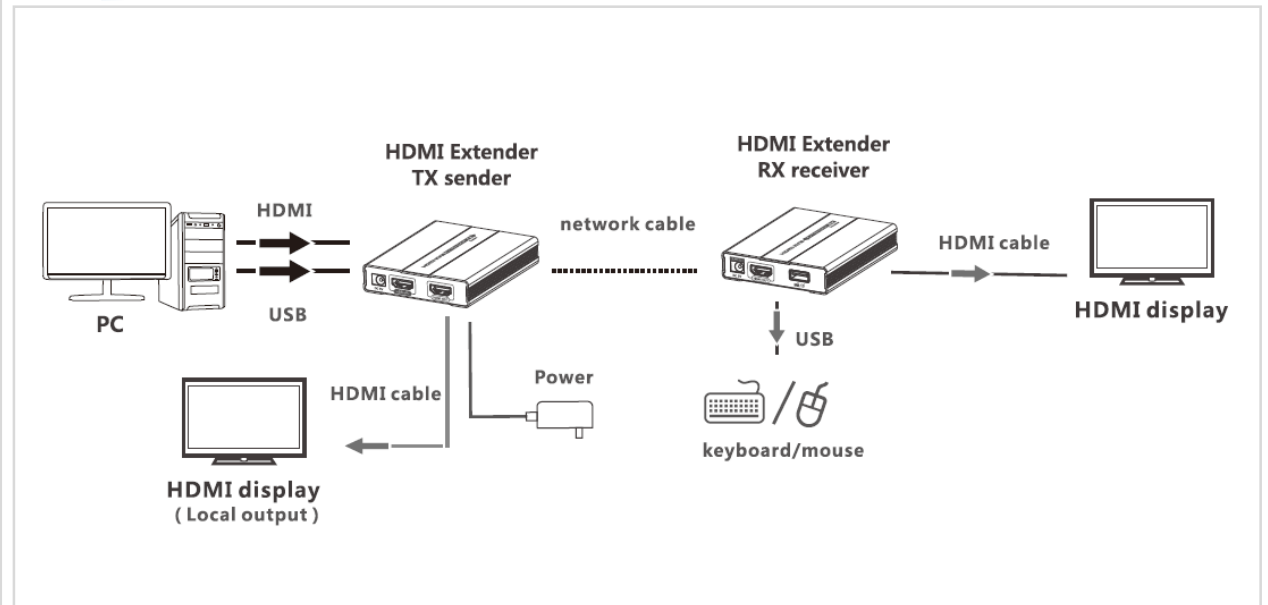

TT-383-VGA

VGA Extender to Cat5e/6 100/120M



- VGA Extender a Cat5e/6 100/120 M
- Conexión en cascada a través de swithes
- Soporta 1TX to 253 RX
- Compatible con TT-383-VGA-RX

1) Conexión 1 a 1

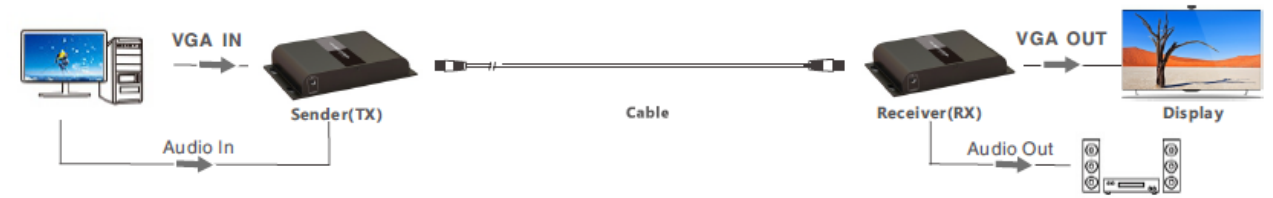

2) Conexión en cascada

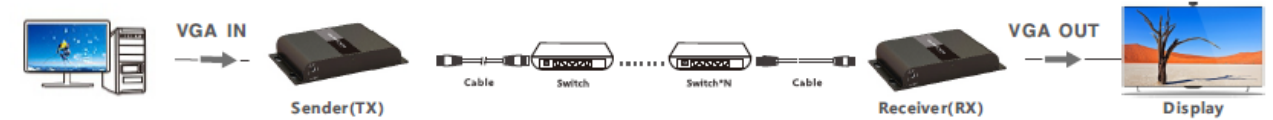

3) Conexión 1 a muchas

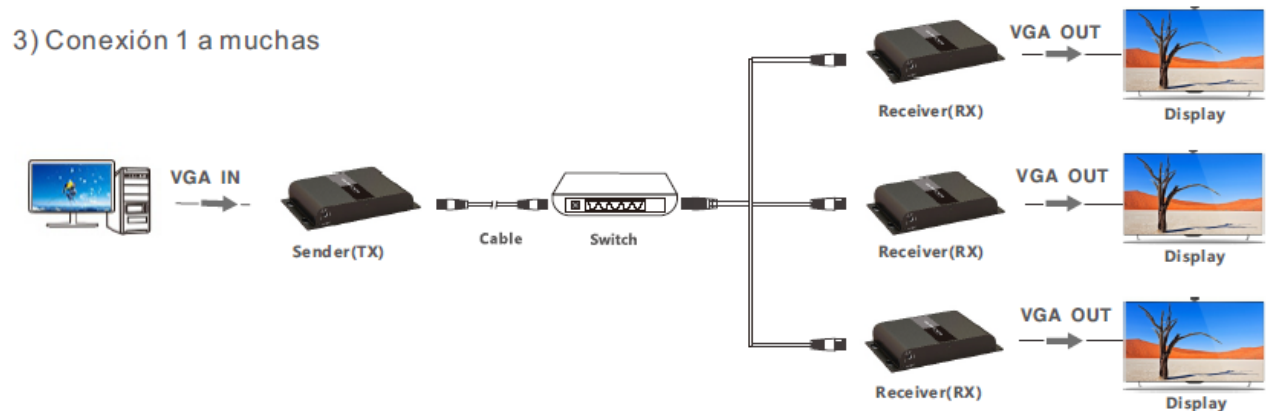

Extensores HDMI Inalámbricos

Modelo	Productos	Características
TT-388-A	Extensor HDMI Inalámbrico	Extensor HDMI Inalámbrico de 200 m, soporta 1TX a 2RX , control IR
TT-388A-RX	Receptor HDMI Inalámbrico	Receptor HDMI Inalámbrico de 200 m, soporta 1TX a 2RX , con IR (Compatible con TT-388-A)
TT-388-Dongle	Dongle HDMI Inalámbrico	Mini Inalambrico HDMI tipo Dongle a 50m,con IR
TT-388-M	Extensor HDMI Inalámbrico	Extensor HDMI Inalámbrico de 50 m, soporta 2TX a 2 RX , con IR
TT-388-MRX	Receptor HDMI Inalámbrico	Receptor HDMI Inalámbrico de 50 m, soporta 2TX a 2 RX , con IR (Compatible con TT-388M)
TT-688	4K Wireless HDMI Extender	4K Wireless HDMI Extender to 200m,with HDMI Loop-out on TX
TT-688N	4K Wireless HDMI Extender	4K Wireless HDMI Extender to 50m,with HDMI Loop-out on TX

TT-388-A

Extensor inalámbrico HDMI para **200 M**



Características

- 1080P @ **200 m / 656ft** Inalámbrico
- Control IR
- Conexión 1TX @ 2RX
- Interconexión con VGA/SDI TX/RX

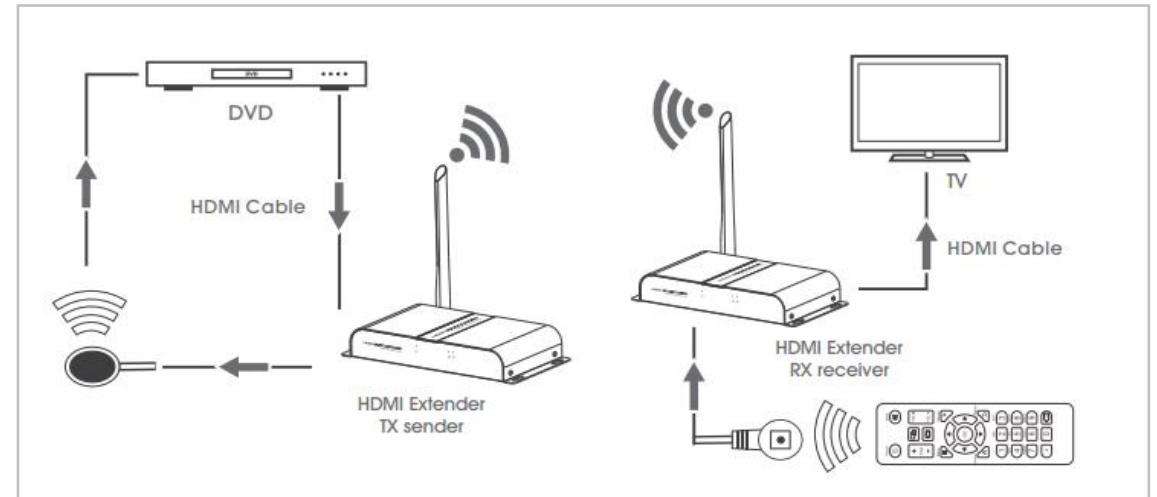

TT-388A-RX

Extensor Inalámbrico HDMI **200M**



Características

- Inalámbrico 1080P @ **200 M**
- Control **IR**
- Soporta conexión **1TX @ 2RX**

■ Conexión 1 a 1

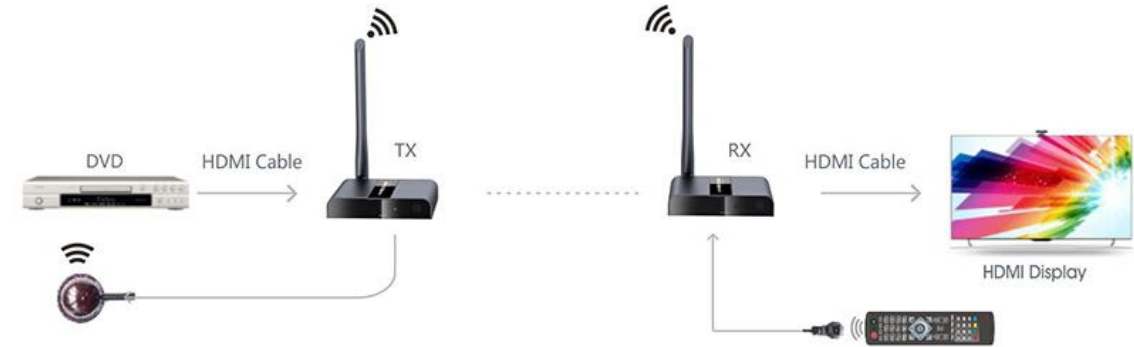

■ Conexión 1 a 2

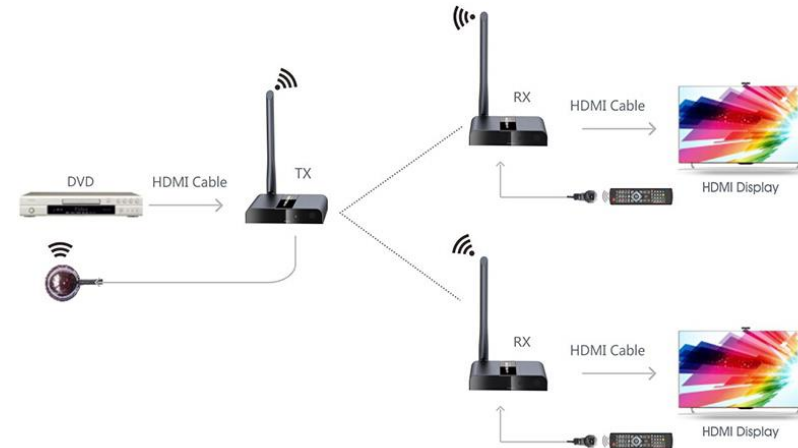

TT-388-Dongle

Inálambrico HDMI tipo Dongle **50M**



Características

- Inalámbrico 1080P @ **50M**
- Control **IR**
- Alimentación de TX por Puerto USB
- **HDMI macho** en el TX

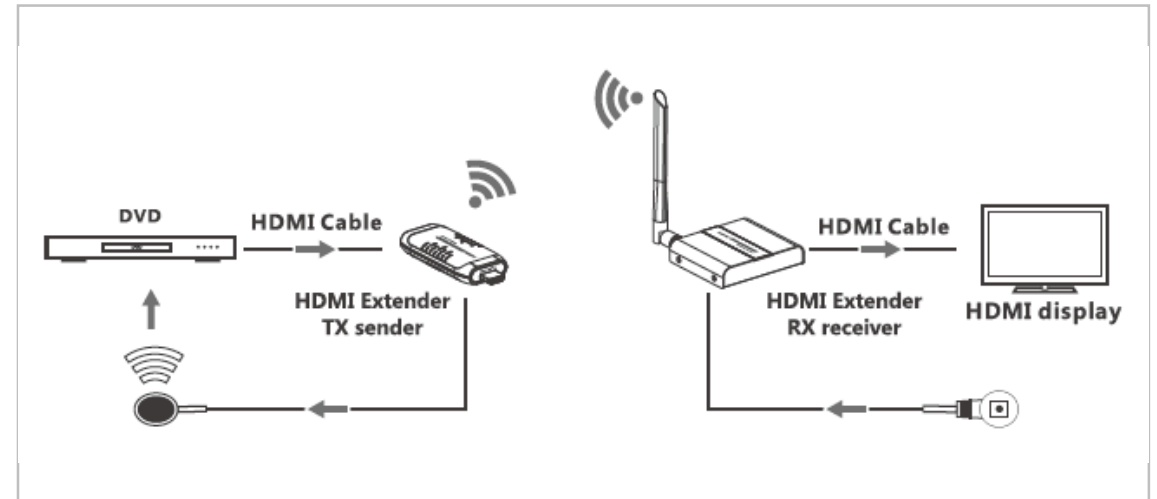

TT-388-M

Kit extensor Inalámbrico HDMI **50M**



Características

- Inalámbrico 1080P @ **50M**
- Control IR
- Soporta conexión 1TX @ 2RX
- Soporta conexión 2TX @ 2RX

■ Conexión 1 a 1

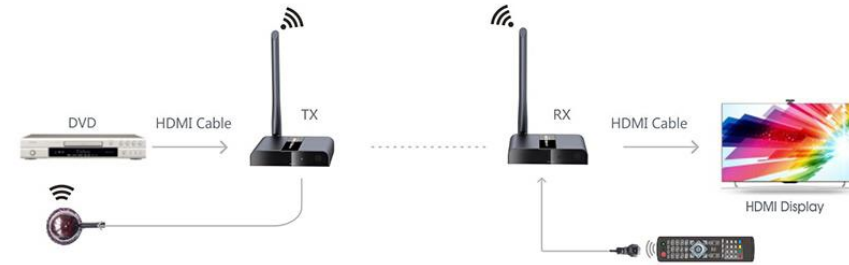

■ Conexión 1 a 2

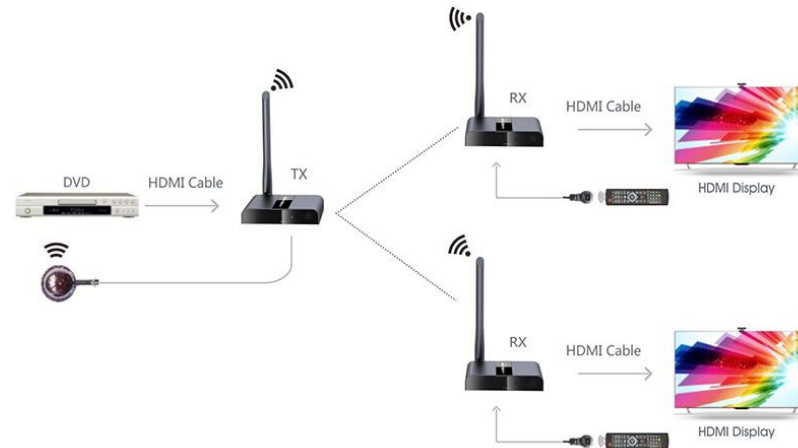

■ Conexión 2 a 2

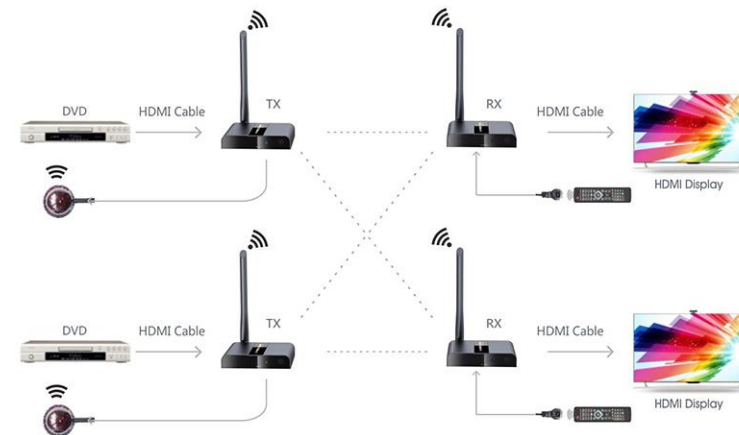

TT-388M-RX

Receptor Inalámbrico HDMI **50M**



Características

- Inalámbrico 1080P @ **50M**
- Control IR
- Soporta conexión 1TX @ 2RX
- Soporta conexión 2TX @ 2RX

■ Conexión 1 a 1

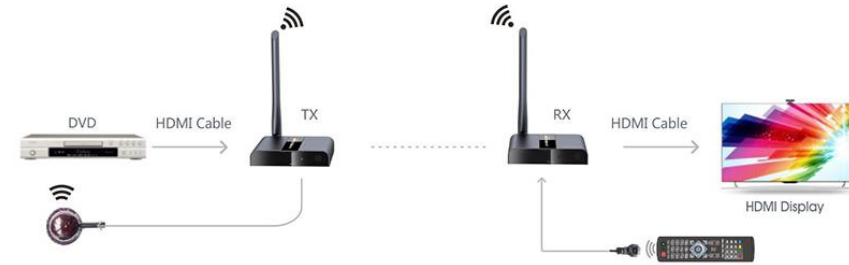

■ Conexión 1 a 2

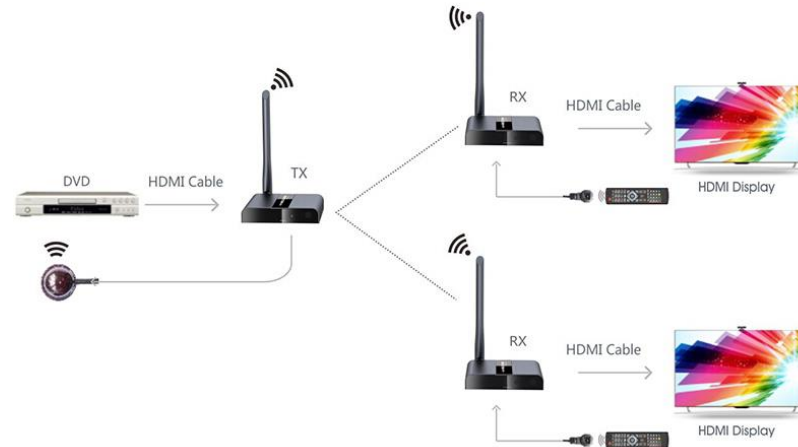

■ Conexión 2 a 2

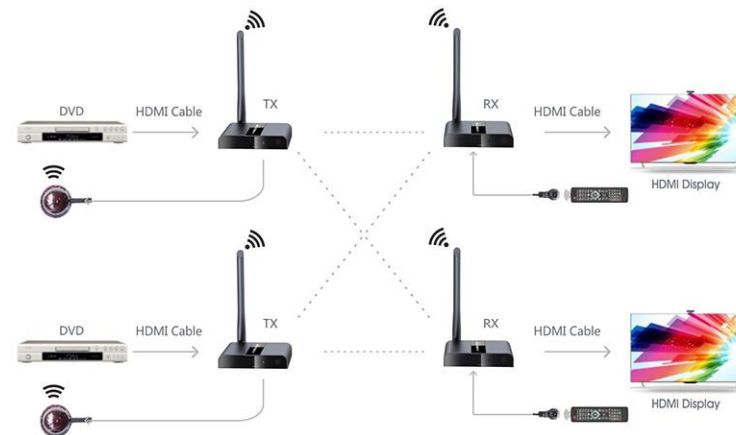

TT-388-IR

Kit extensor Inalámbrico IR de **200 M**

TT388IR

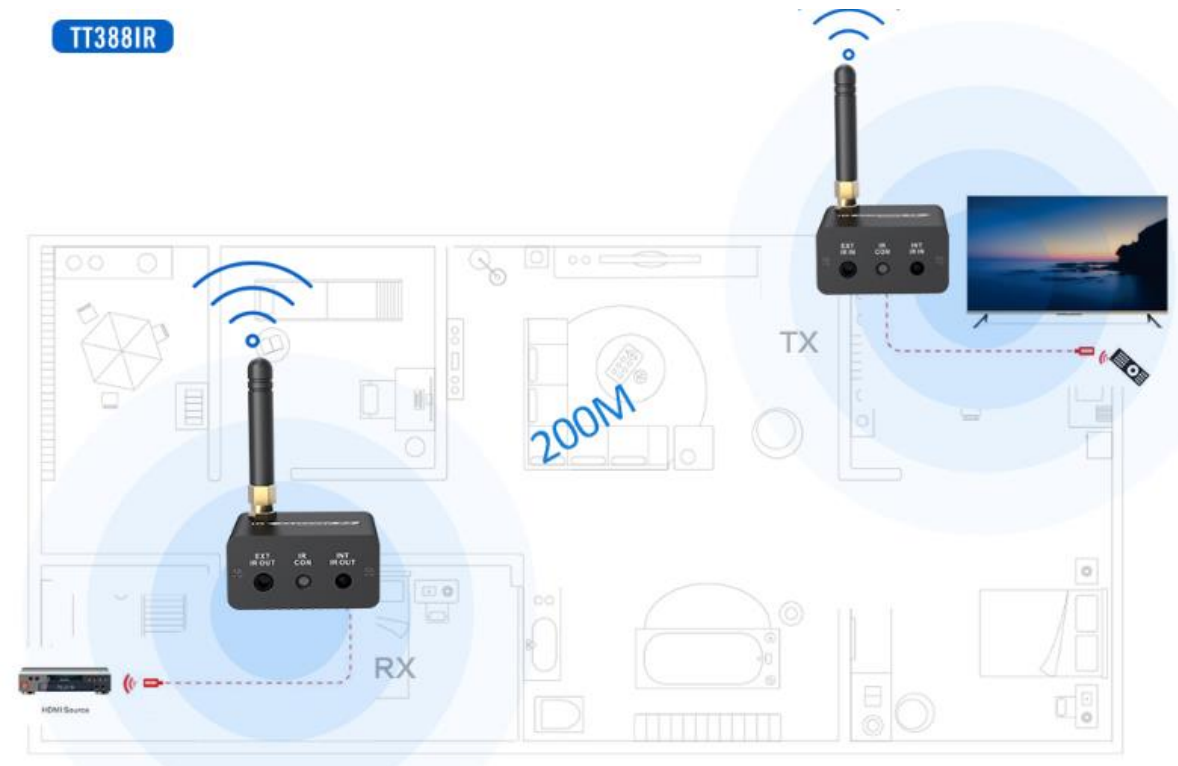

Características

- Señal IR a **200M** inalámbrica
- Muchos kits pueden usarse en el mismo sitio
- Alta sensibilidad



TT-688

Receptor Inalámbrico HDMI **200M** 4KX2K



Características

- Inalámbrico **4KX2K** @ **200M**
- Control **IR**
- Soporta conexión **1TX @ 2RX**

■ Conexión 1 a 1

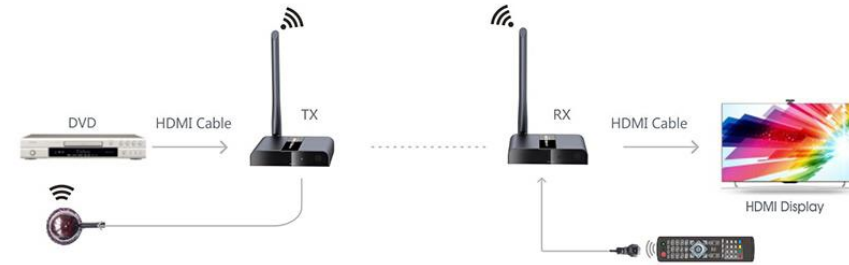

■ Conexión 1 a 2

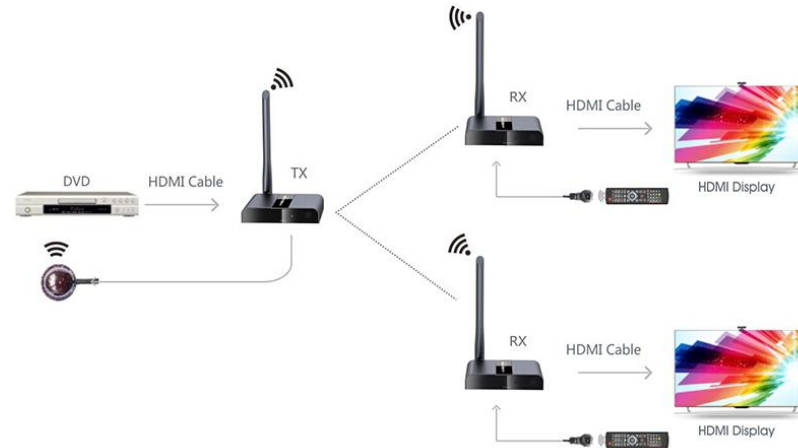

TT-688-N

Receptor Inalámbrico HDMI **50M** 4KX2K



Características

- Inalámbrico **4KX2K** @ **50M**
- Control **IR**
- Soporta conexión **1TX @ 2RX**
-

■ Conexión 1 a 1

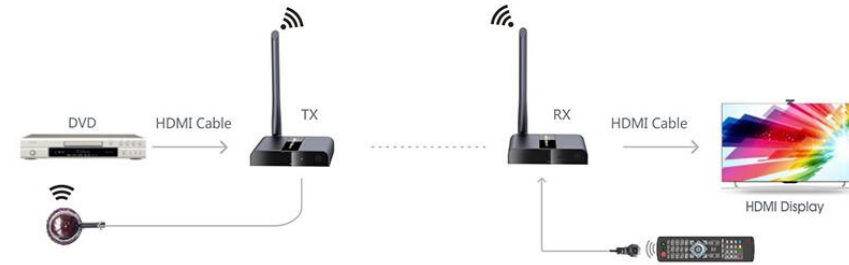

■ Conexión 1 a 2

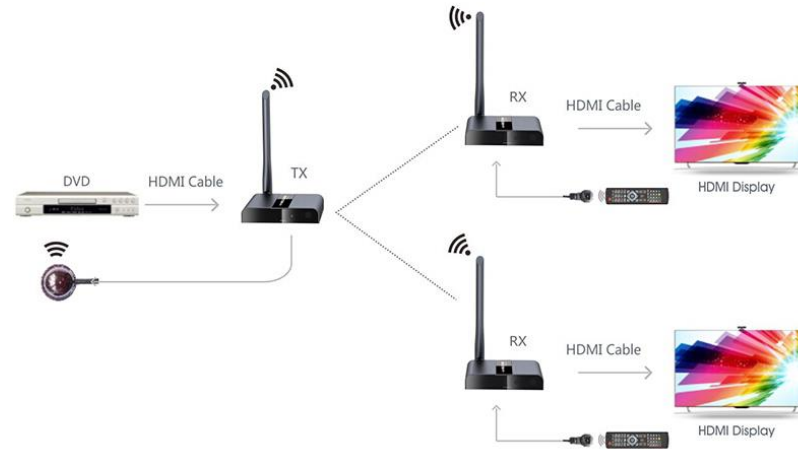

Extensor HDMI sobre Línea Eléctrica

Modelos	Productos	Características
TT-380-PRO	Extensor HDMI	Full 1080P sobre Powerline @ 300M, con Loop & IR
TT-380PRO-RX	Receptor HDMI	Full 1080P sobre Powerline (Receptor)

TT-380-PRO

Extensores sobre Power Line **300M**

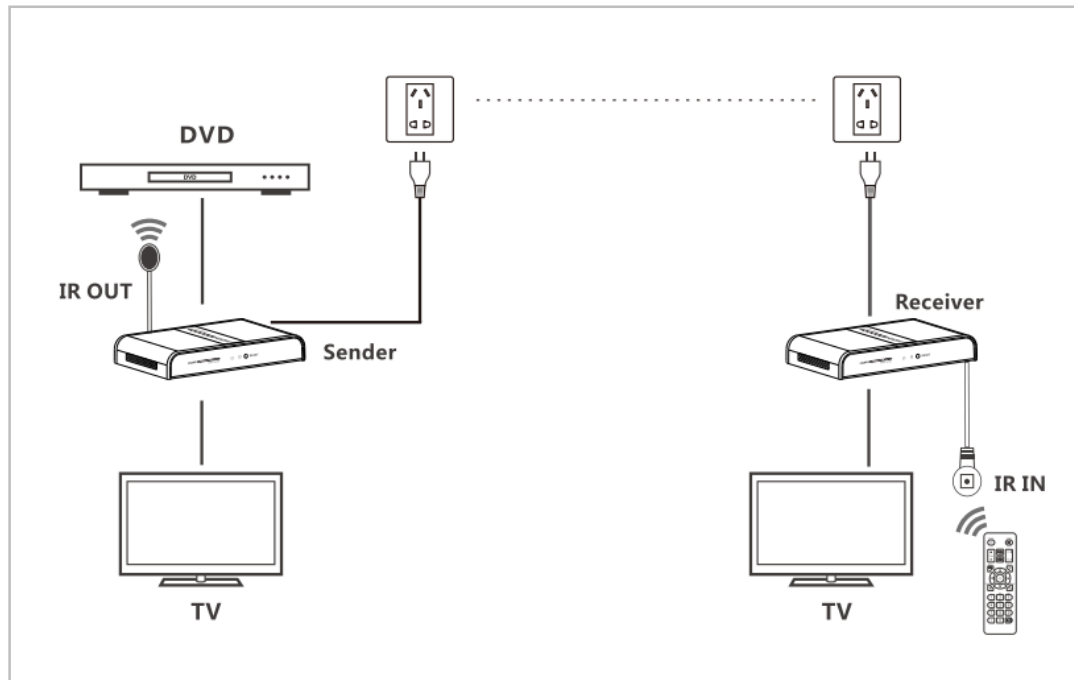

- 1080P sobre Power Line @ **300M**
- Con IR & HDMI Loop-out
- Conexión 1TX to 4RX

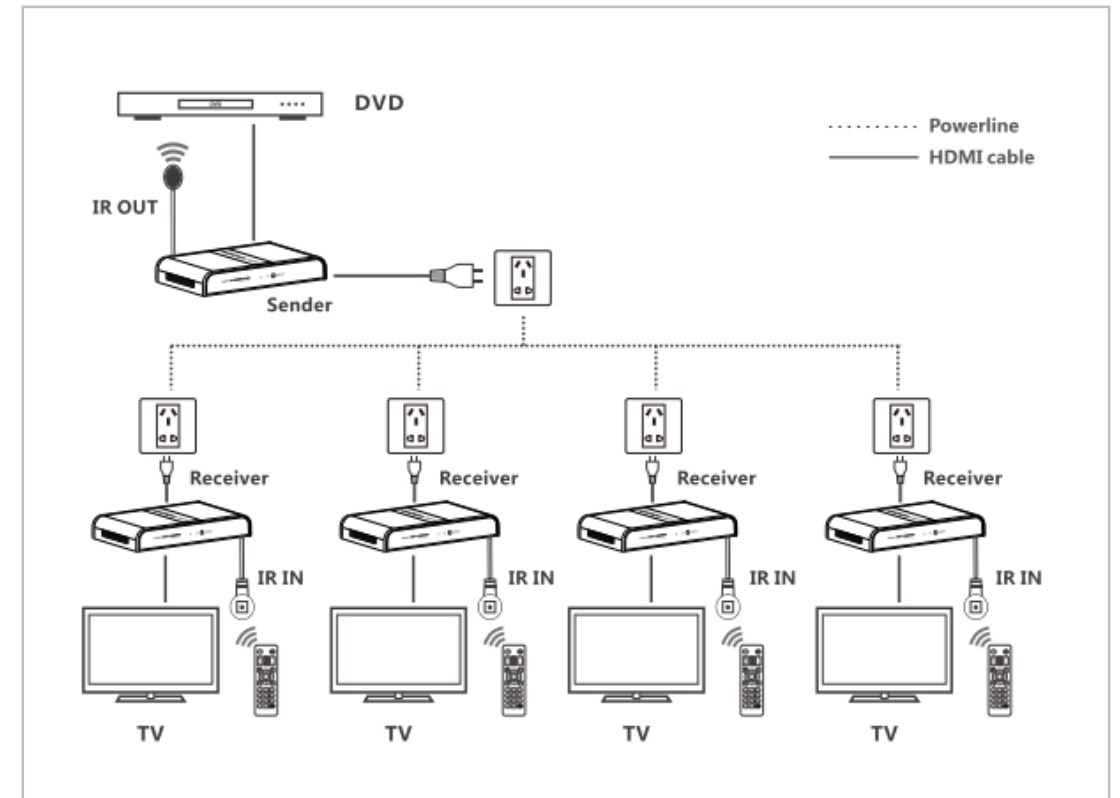

Extensores HDMI por fibra óptica

Model No.	Product	Features
TT-378-A-4K	HDMI Extender	4K x 2K over Fiber to 20KM,with IR

TT-378A-4K

4K x 2K por Fibra a **20KM**



- **4K x 2K** por Fibra óptica a **20KM**
- Con **IR**
- Conexión **1 a muchos**

■ Conexión 1 a 1

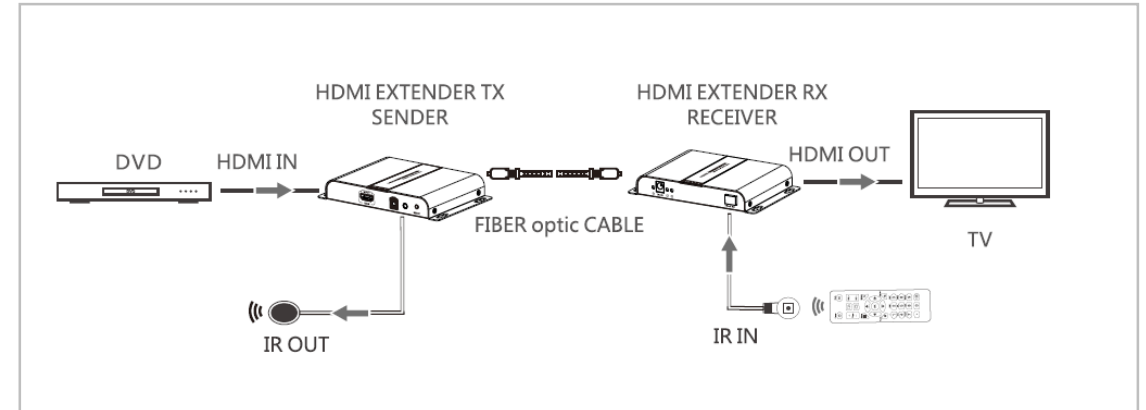

■ Conexión 1 a muchos

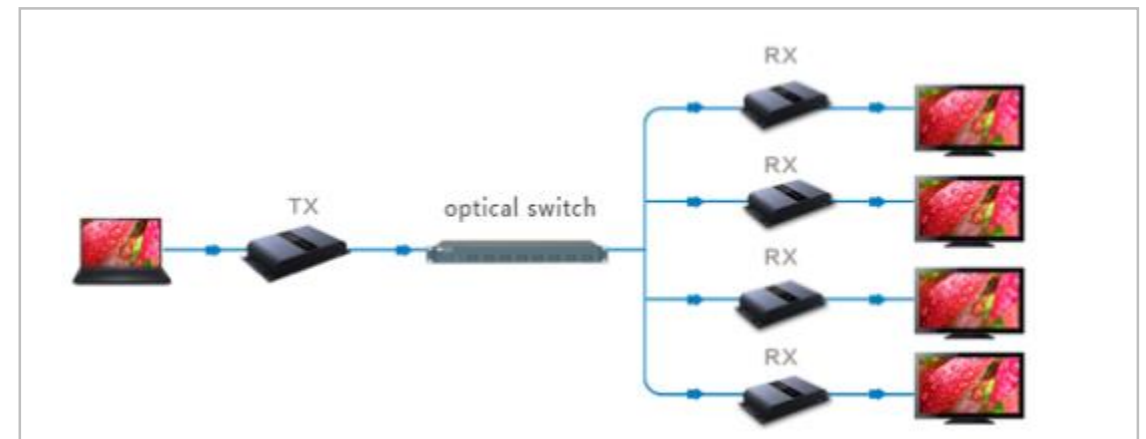

Divisores HDMI

Modelos	Productos	Características
TT-312-V2.0	4K Splitter 1X2	HDMI2.0 4K@60Hz Splitter 1X2
TT-314-PRO	4K Splitter 1X4	4K@30Hz Splitter 1X4
TT-318-PRO	4K Splitter 1X8	4K@30Hz Splitter 1X8
TT-314-4K-HDbitT-TX	4K Splitter 1X4	4K@30Hz Splitter 1X4 use Cat5/6 to 120M, con IR

TT-312-V2.0

4K Splitter 1X2



- HDMI2.0
- HDCP2.2
- UHD4K @ 60Hz
- Splitter 1X2
- HDMI cable 20 m+ 20 m (Uso del TT-168)

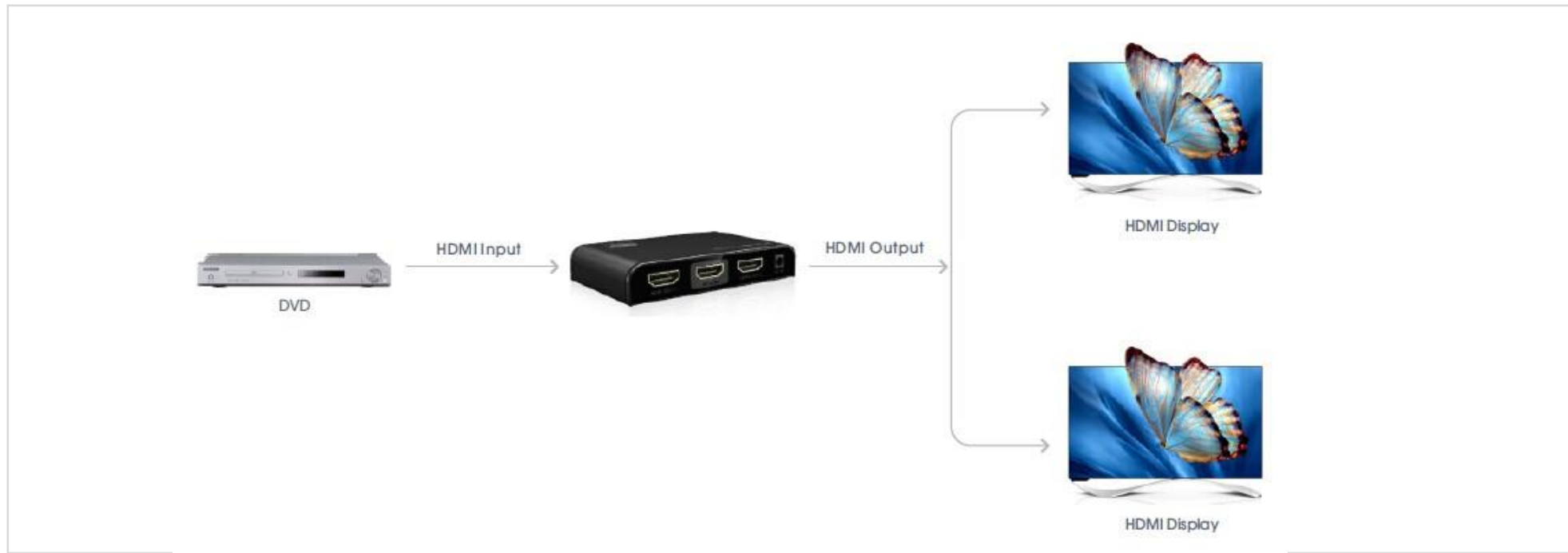

TT-314-PRO

4K Splitter 1X4



- UHD 4K @ 30Hz
- Splitter 1X4
- HDMI cable 20 m+ 20 m (Uso del TT-168)



TT-318-PRO

4K Splitter 1X8



- UHD 4K @ 30Hz
- Splitter 1X8
- HDMI cable 20 m+ 20 m (Uso del TT-168)

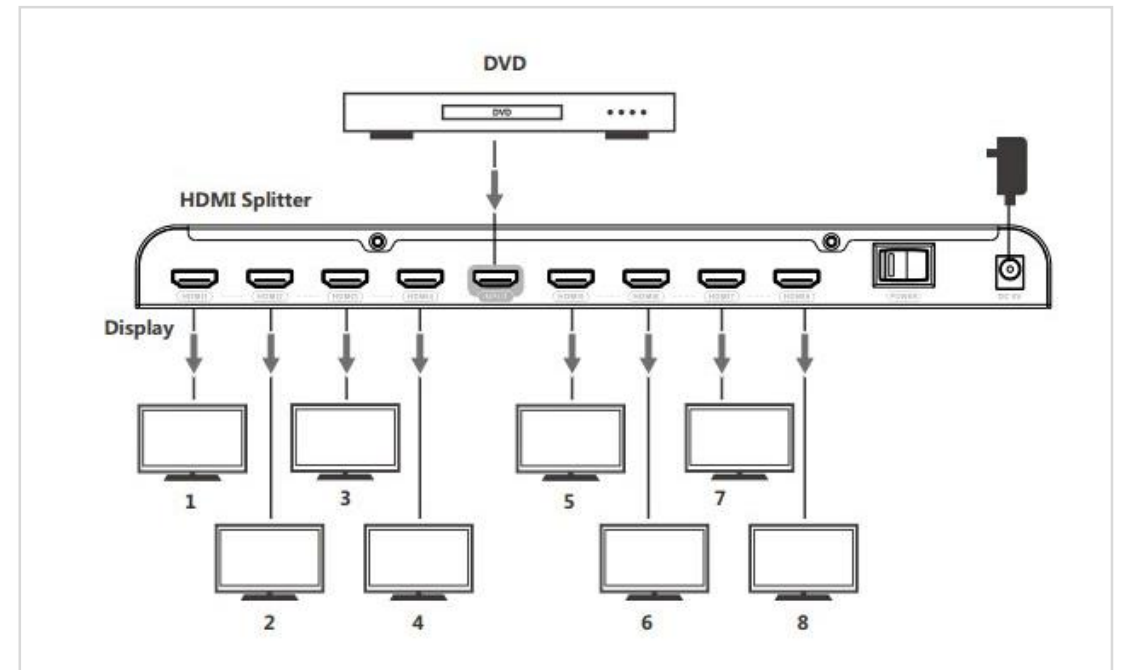

TT-314-4K-HDbitT

HDMI Splitter 1X4 use Cat5 @ **120M**

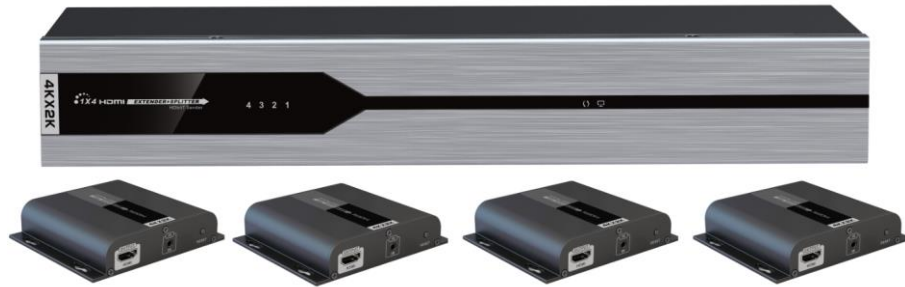

- 4K x 2K Splitter 1X4
- CAT5 @ **120 M**
- Control IR

* Requiere de 4 receptores **TT683RX**

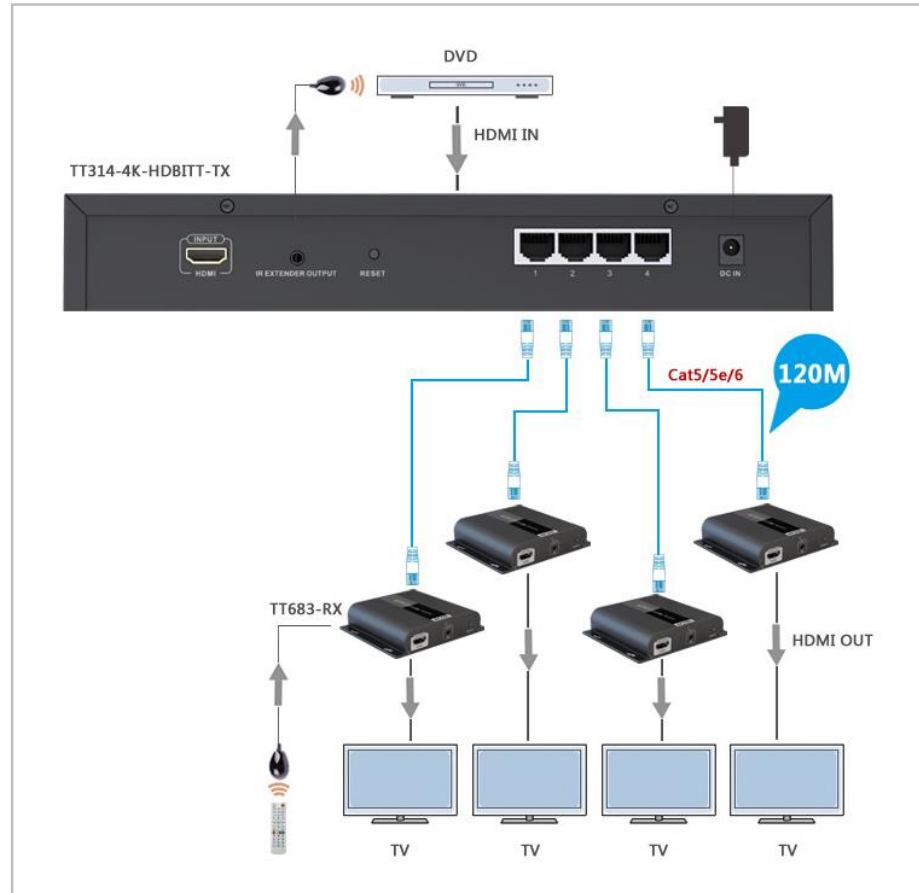

Switch Multiviewer

Modelo	Producto	Características
TT-401MS	HDMI Switch Multiviewer	HDMI Switch pantalla Quad Multiviewer

TT-401-MS

HDMI Pantalla **Quad** Switch Multiviewer



Full mode



Dual mode



Quad mode1



Quad mode2



Quad mode3

- Soporta 4 entradas HDMI, 1 salida HDMI
- Soporta modo quad, pantalla completa, modo dual
- Soporta señal HDMI 1080p @ 60 Hz
- Soporta modo switch por control remoto y botón frontal
- Cero latencia

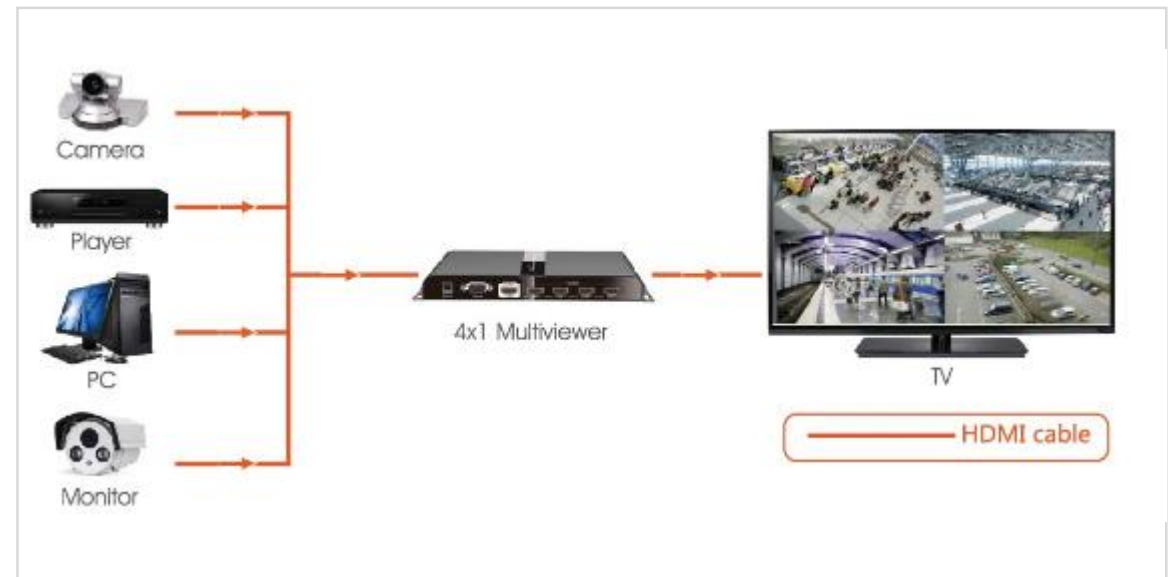

VideoWall

Modelo	Producto	Características
TT-314-VW	Controlador Video Wall	Controlador Video Wall HDMI 2X2

TT-314-VW

Controlador HDMI 2X2 **Video Wall**

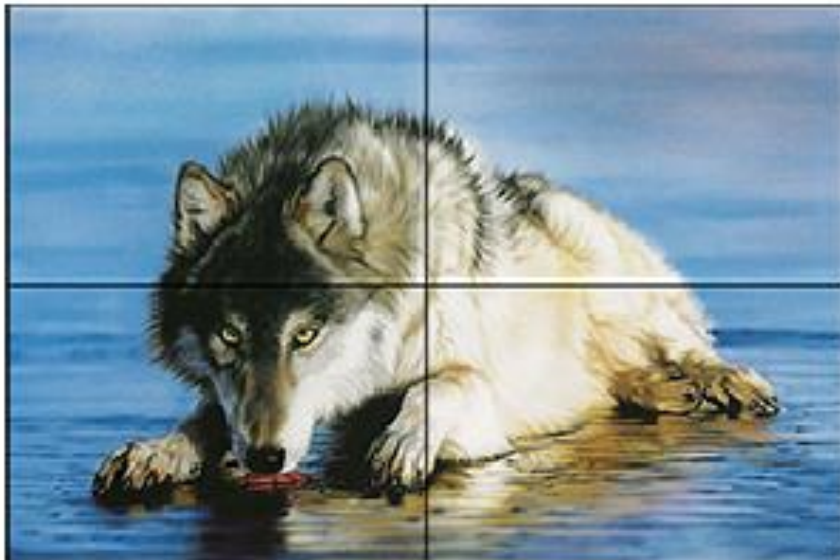

Full Mode

- 4 salidas HDMI, divide el video de entrada en cuatro partes y se extienden a cuatro pantallas del mismo tamaño.
- La resolución admitida es de hasta 1080p a 60Hz.
- Soporta pantalla completa y modo quad.
- Con un puerto de salida de audio de 3.5 mm, acceda fácilmente al equipo de audio.



Clone Mode

Video Switch

Modelo	Producto	Características
TT-501-V2.0	4K Switch 5X1	HDMI2.0 4K Switch 5X1

TT-501-V2.0

4K Switch **5X1**



- **HDMI2.0**
 - **HDCP2.2**
 - **UHD4K @ 60Hz**
 - **Switch 5X1**
 - **HDMI cable 20m+20m (Uso del TT-168)**
-



HDMI Matrix Switch

Modelo	Producto	Características
TT-414	HDMI Matrix 4X4	4K Matrix 4 X 4
TT-818	HDMI Matrix 8X8	4K Matrix 8 X 8
TT-383-MATRIX	HDMI Matrix Extender	Full 1080P Cat5e/6 @ 120/150 M, con IR and Matrix
TT-383-MATRIX-RX	Receptor HDMI Matrix	Full 1080P Cat5e/6 @ 120/150 M, con IR and Matrix
TT-683-MATRIX	4K Matrix Extender	4K@30Hz over Cat5/6 to 120M,with IR and Matrix
TT-683-MATRIX-RX	4K Matrix Receiver	4K@30Hz over Cat5/6 to 120M,with IR and Matrix

TT-414

4K X 2K HDMI Matrix Switch 4X4



4K

4Kx2K@30Hz

**YUV4
4:2:2**

YUV4:2:2

**10.2
Gbps**

10.2Gbps

**HDMI
1.4**

HDMI1.4

**HDCP
1.4**

HDCP1.4

3D

3D

- 4 HDMI inputs & 4 HDMI outputs
- 4K X 2K @30HZ
- YUV : 4: 2: 2
- 3D, Control remoto , RS232, Control por botón

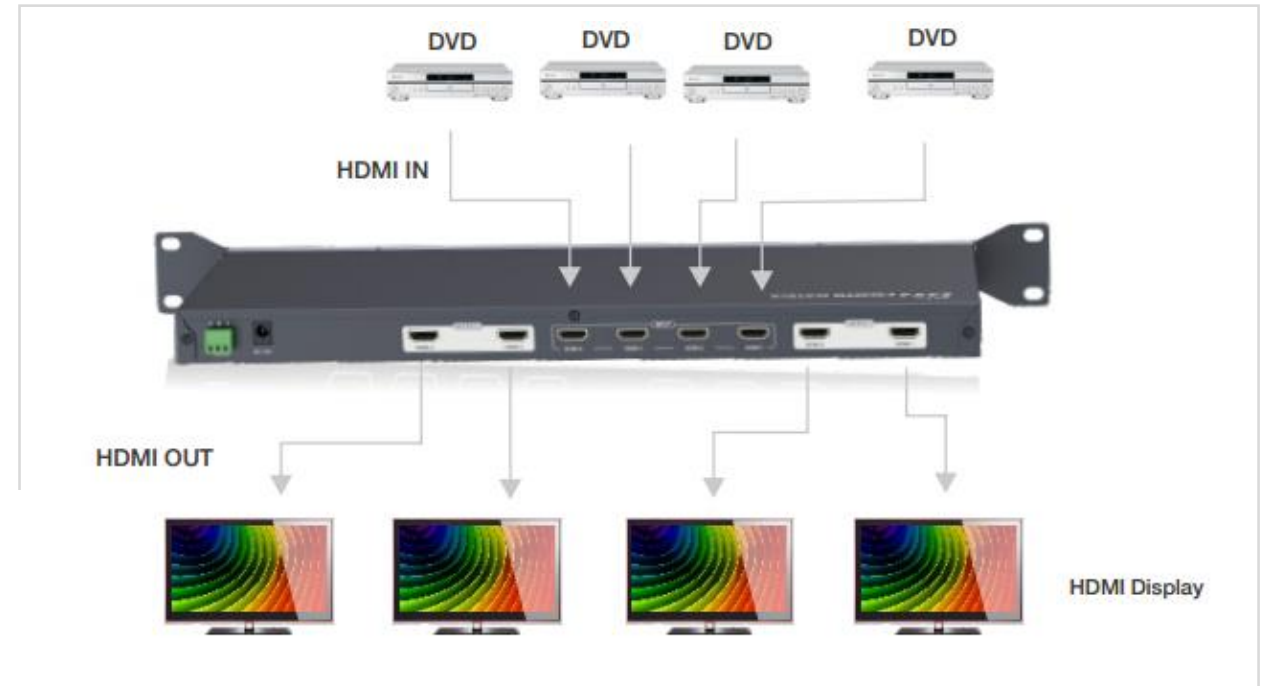

TT-818

4K X 2K HDMI Matrix Switch 8X8

- 8 HDMI inputs & 8 HDMI outputs
- 4K X 2K @30HZ
- YUV : 4: 2: 2
- 3D, Contro remote, RS232, Control por botón

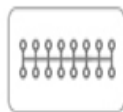
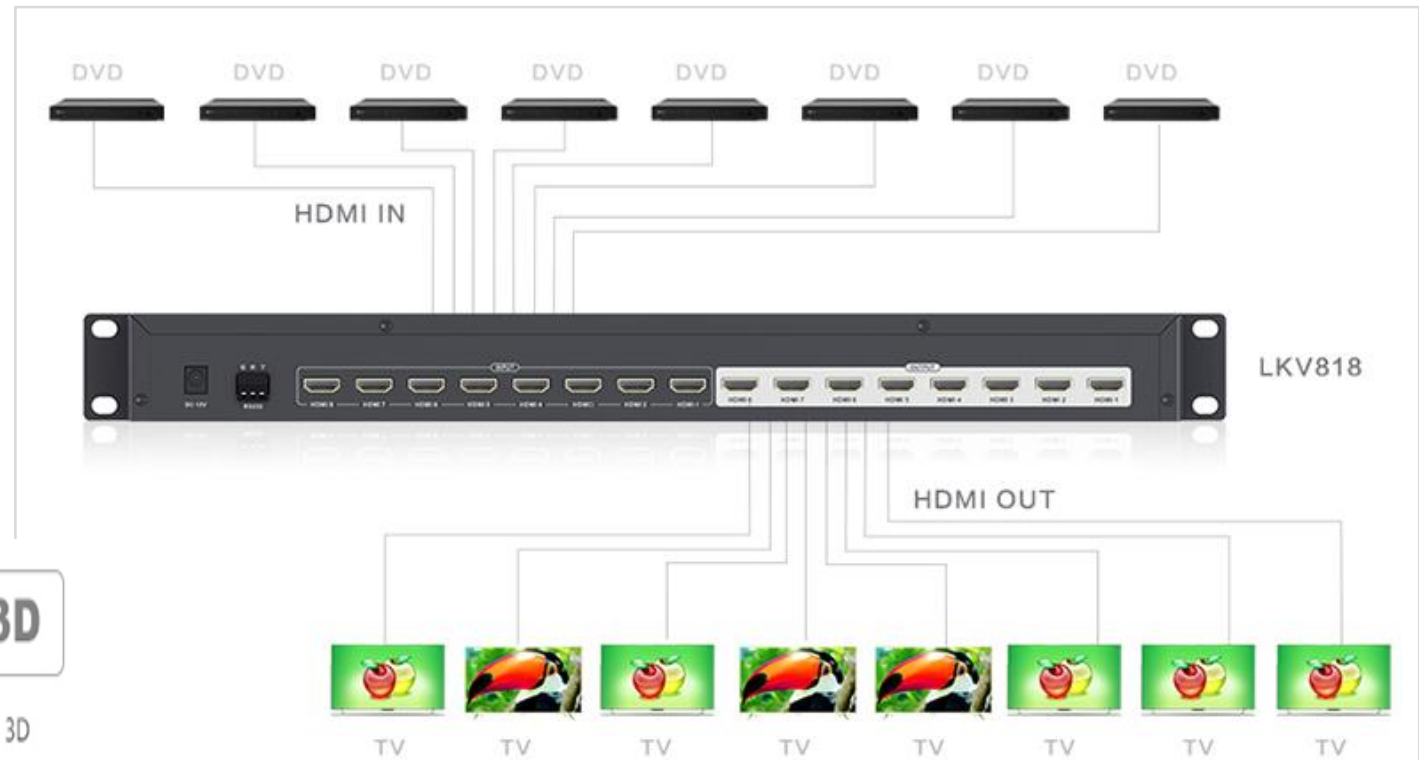

8 input 8 output



4Kx2K@30Hz

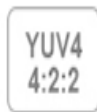

YUV4:2:2

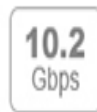

10.2Gbps



HDMI1.4



HDCP1.4



3D

TT-383-MATRIX

Extenders over IP CAT Cable **MATRIX**

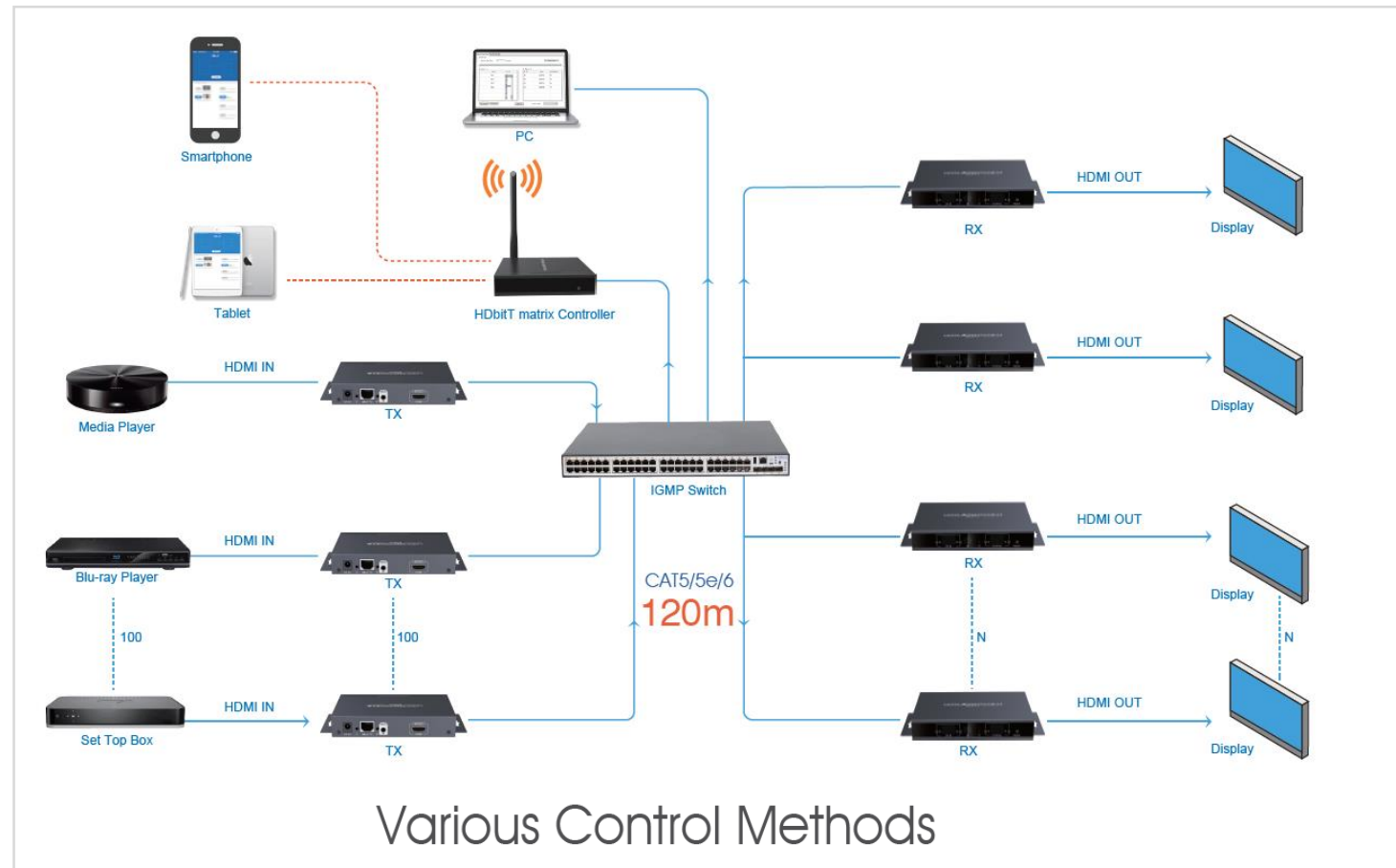

Various Control Methods

- 1080P por Cat5/6 to **120M/150M**
- Canales de entrada máximo 100
- **Salidas ilimitadas**
- Control remote, PC , Botón en receptor y control por APP



APP Control
(Android, ios, PC)



IR Control
(20~60KHz IR frequency range)

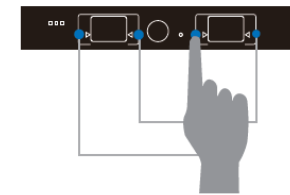

Hard Button Control
(Select and switch source)

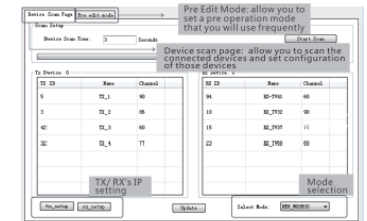

Via Webpage Control
(Login IP:192.168.2.XXX)

TT-683-MATRIX

4K X 2K

Extenders over IP CAT Cable **MATRIX**



- **4K X 2K** por Cat5/6 a 120M/150M
 - Máximo número de entradas: 100
 - **Salidas ilimitadas**
- Contro remote ,PC, Botón en receptor y APP

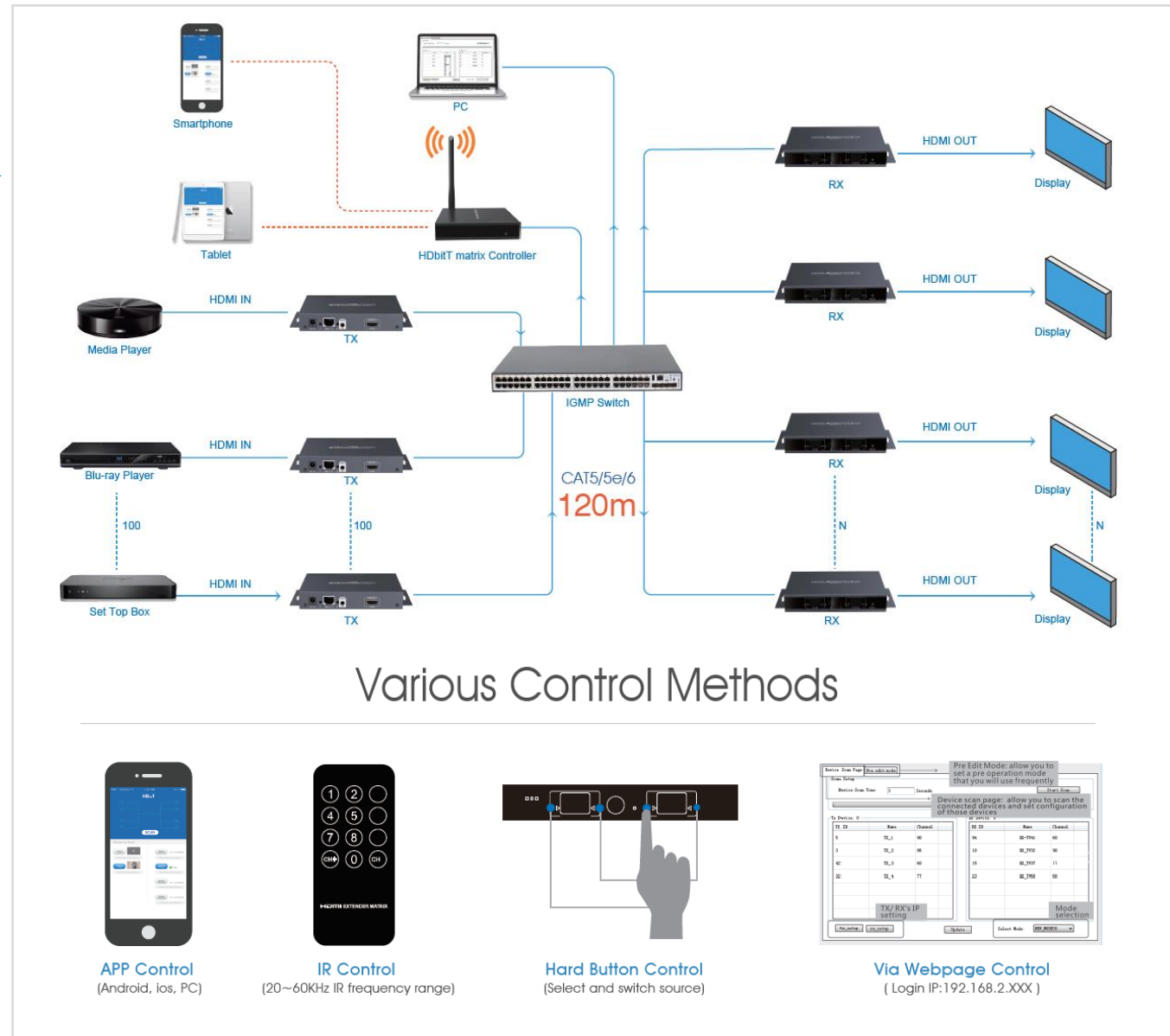

TT-683-MATRIX-RX

4K X 2K

Receptor por UTP Cable **MATRIX**



- **4K X 2K** por Cat5/6 a **120M/150M**
- Máximo 100 entradas de canal
- **Salidas ilimitadas**
- Remota , PC, Botón RX y control APP

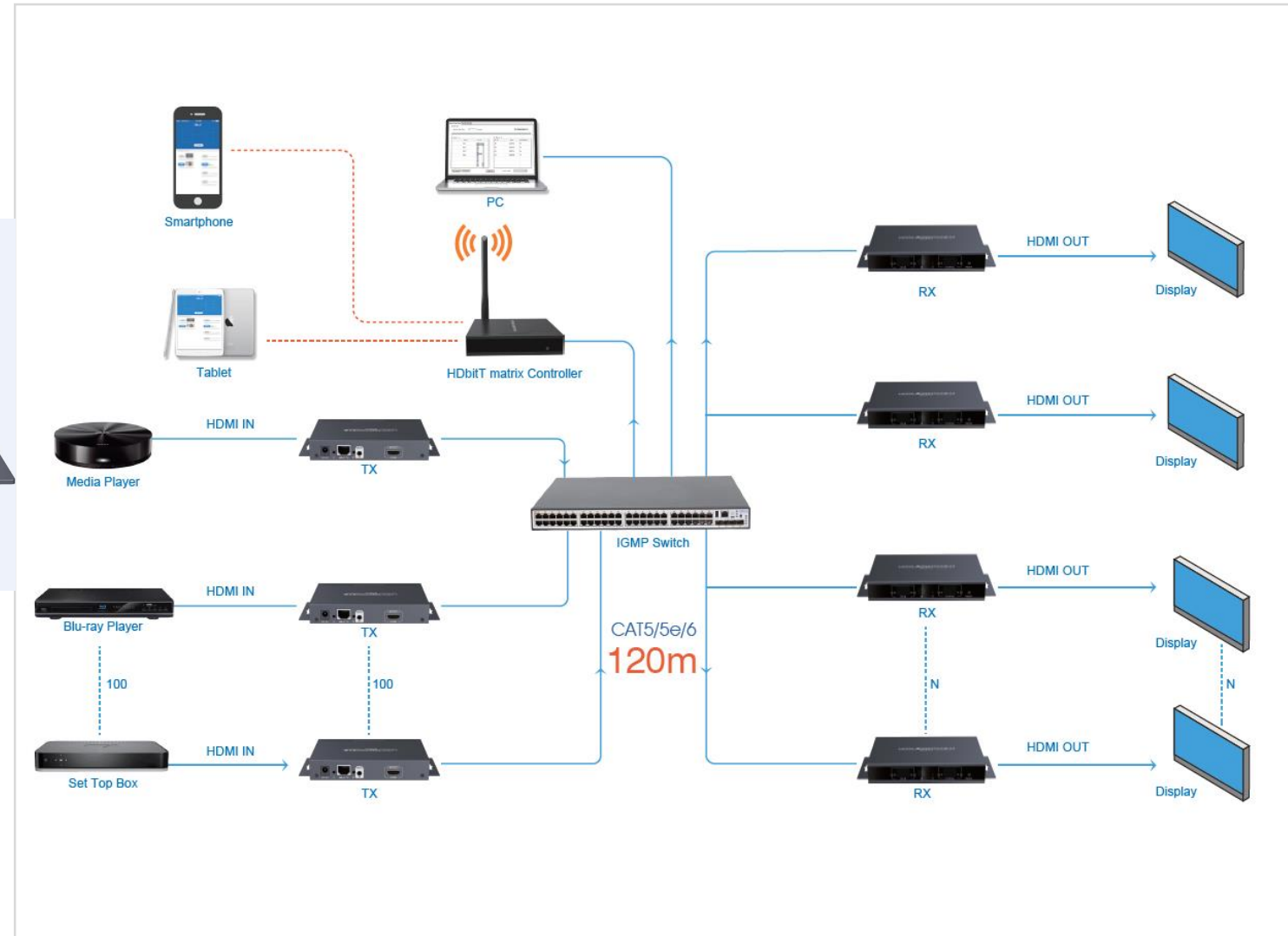

HD-MC-001

Controlador de **MATRIX**

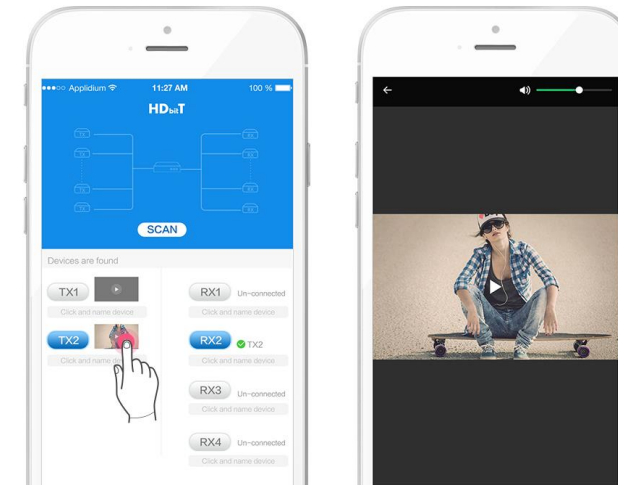
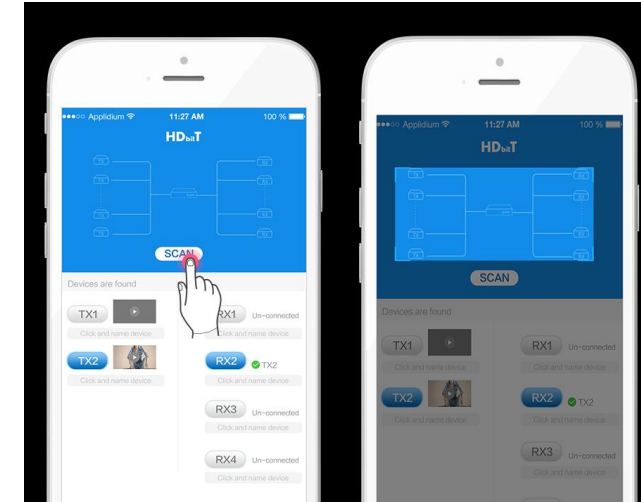
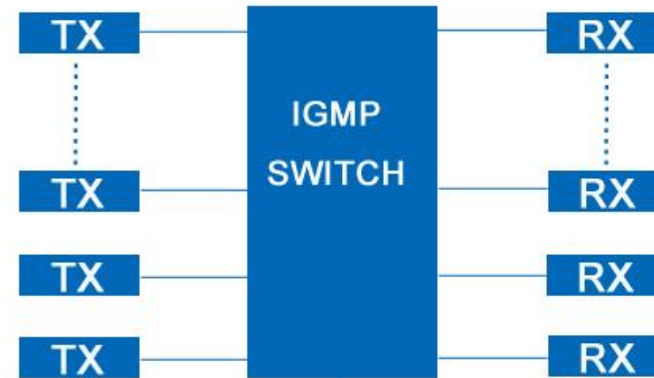

- **Controlador inalámbrico** para **TT383Matrix** y **TT683Matrix**
- Usado para **APP** POR smart phone o laptop
- Función de avance
- Configuración para ID de TX Y RX
- Fácil cambio de canal

Kits HDMI

Modelo	Producto	Características
TT-714-PRO	HDMI Splitter 1X4	HDMI Splitter 1X4 over Cat6 to 40M, con IR
TT-718-PRO	HDMI Splitter 1X8	HDMI Splitter 1X8 over Cat6 to 40M, con IR

TT-714-PRO

HDMI **Splitter 1X4** use Cat6 @ **40M**

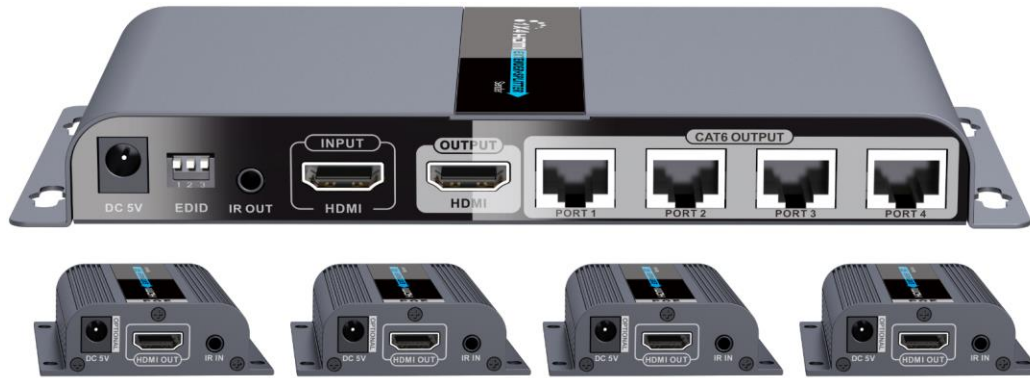

- Full 1080P Splitter **1X4**
- Use CAT6 @ **40 m**
- **PoC**- 1 sola fuente de alimentación en el TX
- **HDMI Loop-out**
- Control **IR**

Conexión

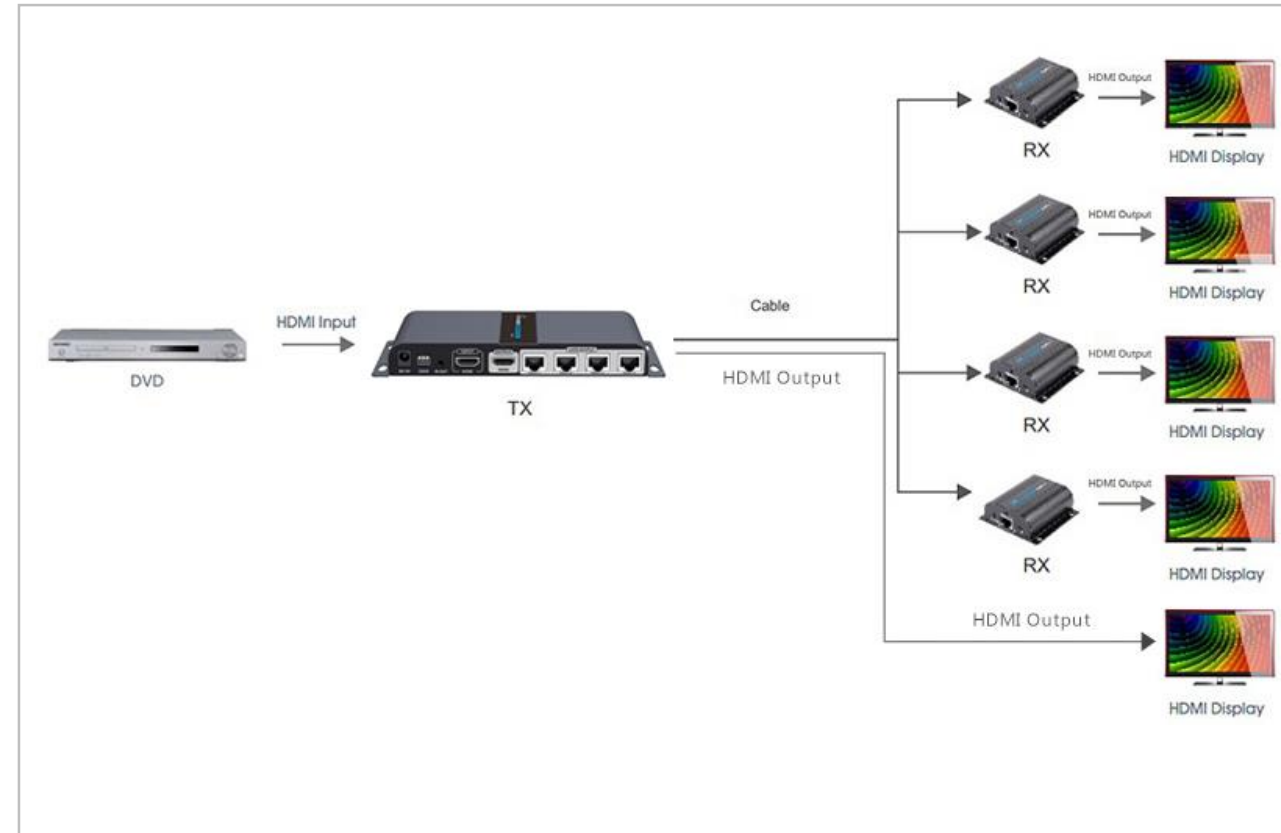

TT-718-PRO

HDMI **Splitter 1X8**; use Cat6 @ **40M**



- 1080P Splitter **1X8**
- Use CAT6 to **40M**
- **PoC-1** sola Fuente en el TX
- **HDMI Loop-out**
- **Control IR**

Conexión

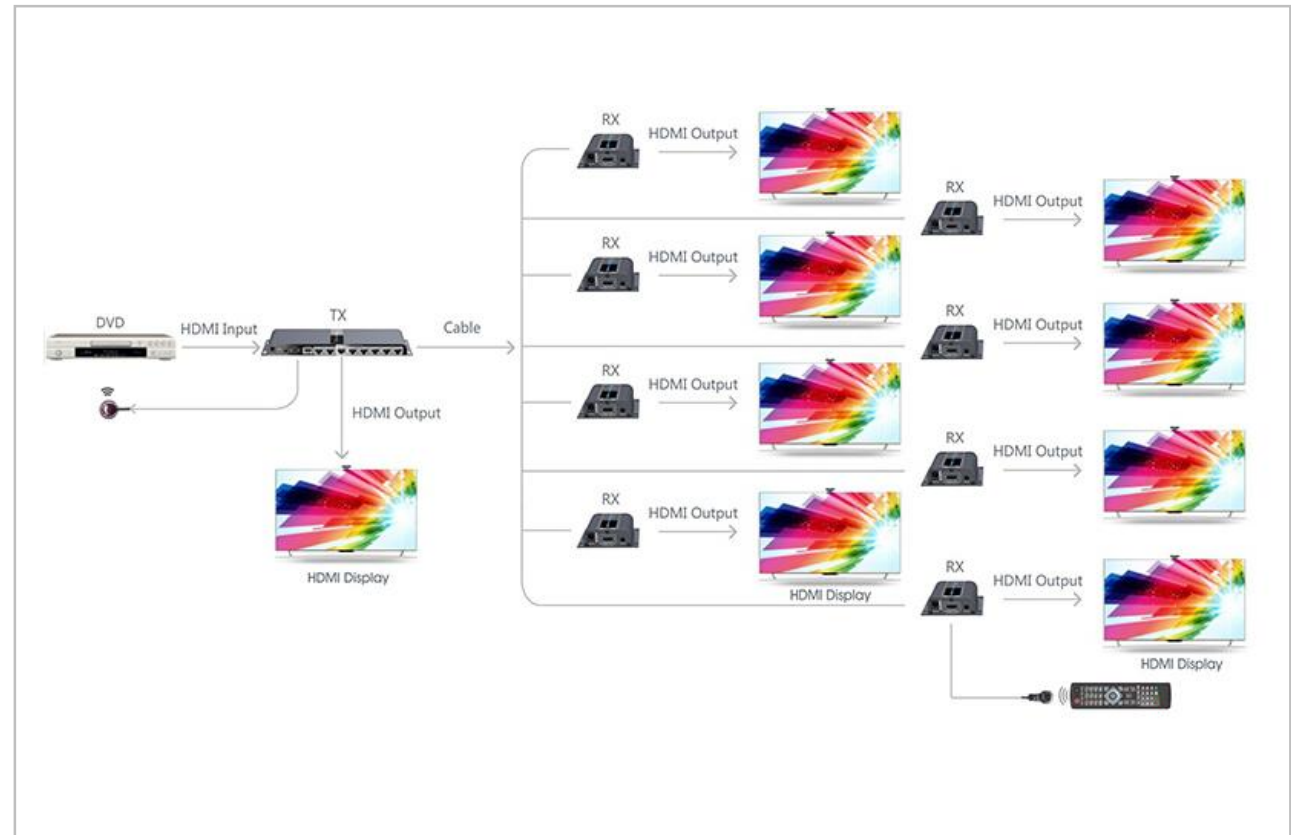

Convertidores VGA-HDMI

Modelo	Producto	Características
TT-350-MINI	Convertidor VGA a HDMI 1080p	Mini Convertidor VGA a HDMI; 1080 p
TT-352-4K	Convertidor VGA a HDMI 4K	Convertidor VGA a HDMI 4K

TT-350-MINI

Convertidor **VGA a HDMI**



- **VGA a HDMI**
 - 1080P @60Hz
 - Plug & Play
-



TT-352-4K

Convertidor **VGA a HDMI**



- VGA a HDMI
 - **4k x 2k @ 60Hz**
 - Plug & Play
-



Repetidor amplificador HDMI

Modelo	Producto	Características
TT-168	Amplificador HDMI	Repetidor amplificador HDMI

TT-168-4K

Extensor Repetidor / Amplificador HDMI



- Soporta **4X x 2K**
- Longitud Máxima **40M**
- Plug & Play / Requiere 5 Vcd, entrada micro-usb

Aplique la solución más nueva del extensor repetidor, con capacidad de transmitir la señal de HDMI hasta 40 metros (20 metros de la fuente principal más 20 metros del extensor hacia su Smart TV). La solución más práctica y sencilla en sus proyectos.



TT-7505

Convertidor de S-VIDEO / BNC a **VGA**

- Salida : **VGA**
- Entrada : **S-VIDEO**
- Entrada : **BNC**

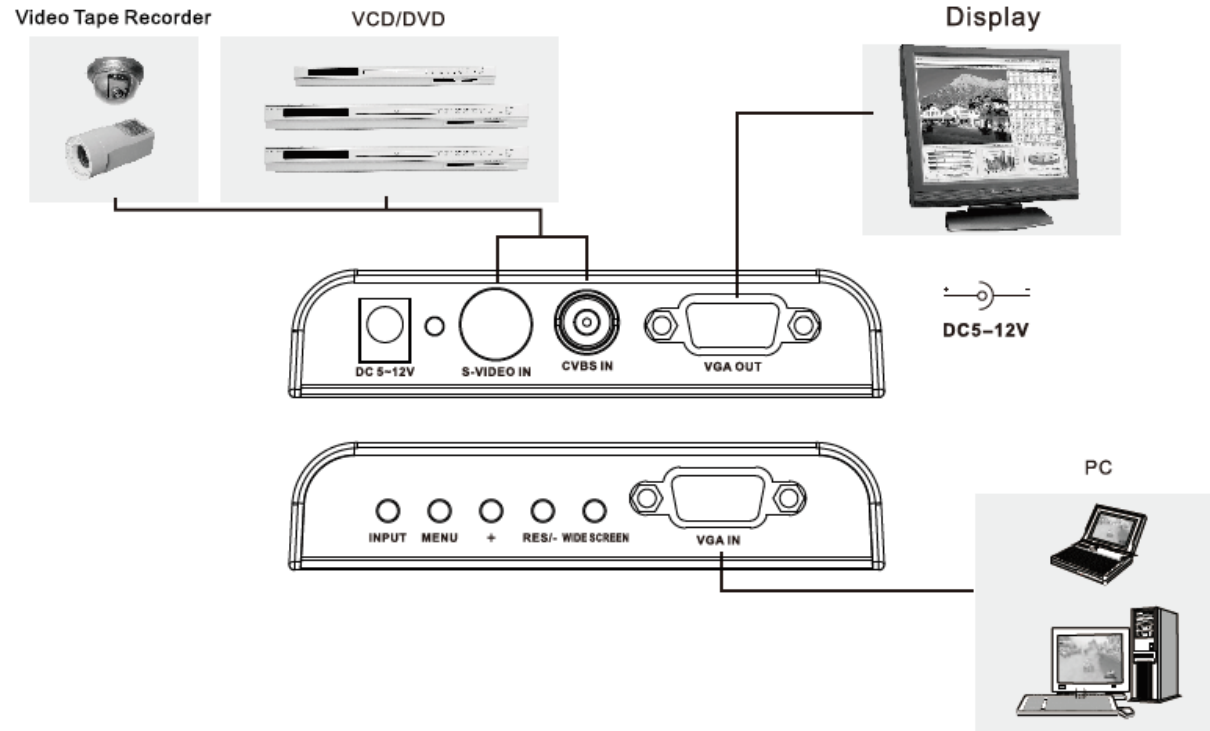

SYSCOM

WWW.SYSCOM.MX