

4Kx2K HDbiT HDMI Extender

User manual

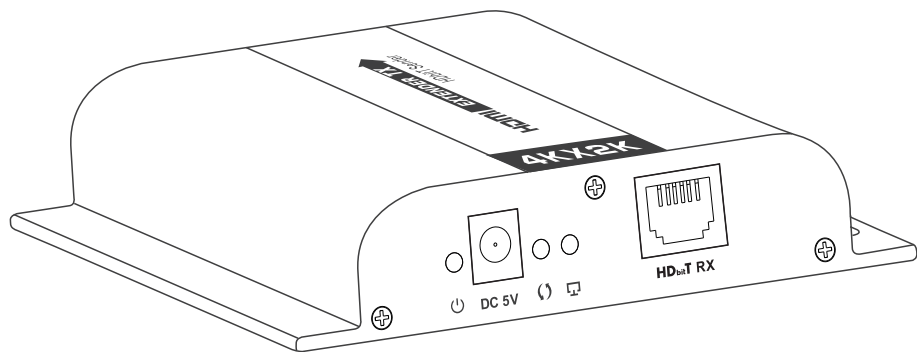
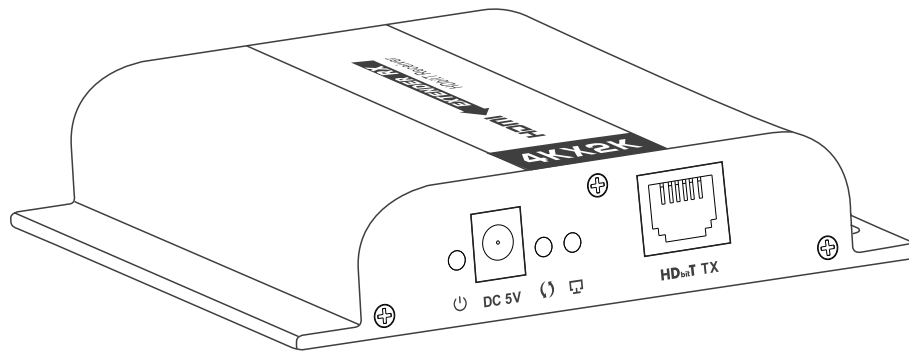

Thank you for purchasing this product. For optimum performance and safety, please read the instructions carefully and keep the manual for future reference.

- **Important safety notice**

Please read below safety instructions carefully before installation and operation:

- * Please pay attention to all the warnings and hints on this device.
- * Do not expose this unit to rain, moisture and liquid.
- * Do not put any stuff into the device.
- * Do not repair or open this device without professional people's guidance.
- * Make sure good ventilation openings to avoid product overheating damage.
- * Shut off power and make sure environment is safe before installation.
- * Do not plug-in/out the network cables and IR cables when it is in using to avoid cables damage.
- * Use DC5V only. Make sure the specification matched if using 3rd party DC adapters.

- **Introduction**

HDMI HDbiT extender, takes the advantages of the latest transmission technology - HDbiT, extends your HDMI video/audio with the resolution of 4Kx2K 30Hz up to 120m(394 feet) via single network cable. Supports IR signal transmission, to control media playback of the signal source device at the display location.

• Package Contents



HDMI EXTENDER sender TX ×1pcs



HDMI EXTENDER receiver Rx ×1pcs

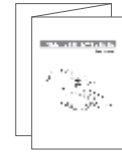

User Manual ×1pcs

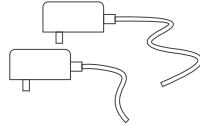

DC5V/2A ×2pcs



IR blaster extension cable*1pcs

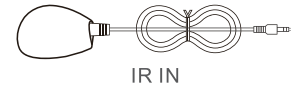

IR receiver extension cable*1pcs

• Installation Requirements

1. HDMI source device(computer graphics card, DVD,PS3, HD monitoring equipment etc).
2. HDMI display device like SDTV, HDTV, projector with HDMI port.
3. Network cables : UTP/STP Cat5e/6 network cables, which following the standard of IEEE-568B.

Transmission length: CAT5 80m/CAT5E 100m/CAT6 120m.

• Panel Description

1. HDMI EXTENDER TX (Sender)

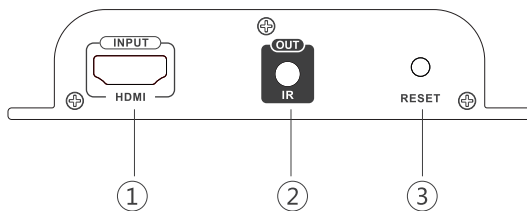

- ① Reset
- ② HDMI signal input
- ③ IR signal output to connect with blaster extension cable
- ④ Power Light

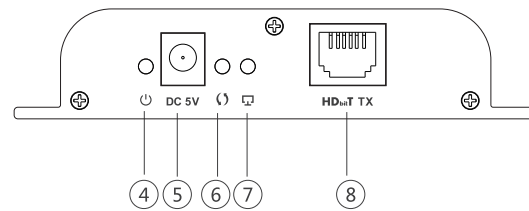

- ⑤ Power input (DC5V)
- ⑥ Data transmission light
- ⑦ Network link light
- ⑧ HDbitT signal output

2. HDMI EXTENDER RX(Receiver)

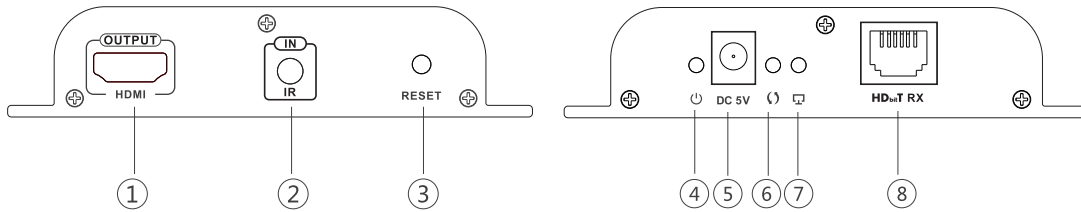

- ① Reset
- ② HDMI signal output
- ③ IR signal input to connect with IR receiver extension cable
- ④ Power Light
- ⑤ Power input (DC5V)
- ⑥ Data transmission light
- ⑦ Network link light
- ⑧ HDbitT signal input

• Installation Procedures

1. How to make a Cat5e/6 network cable

Follow the standard of IEEE-568B:

- | | | |
|----------------|--------------|---------------|
| 1-Orange/white | 4-Blue | 7-Brown/white |
| 2-Orange | 5-Blue/white | 8-Brown |
| 3-Green/white | 6-Green | |



2. Connections

2.1 Point to Point connection: Up to 120 meters transmission distance over single CAT6 (High quality cable can reach 150 meters) .

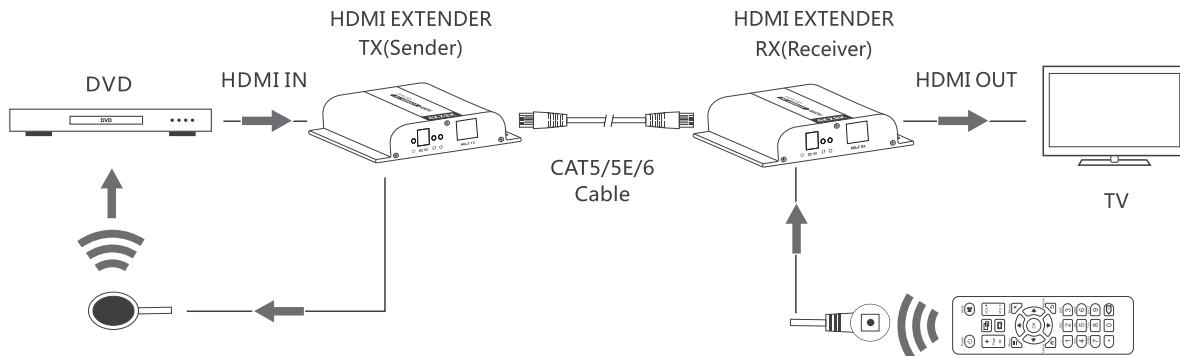

Q: Display not fluent, not stable?

A: 1) Please check the cable length between the TX to switch, the switch to the RX and the connection between each level is within the required range.

2) Click the "reset" button on the TX/RX front panel, reset and reconnect.

• Specification

Items	Specifications
HDMI Signal	Compatible with HDCP
transport protocol	HDBiT
Support resolutions	480i@60Hz, 480p@60Hz, 576i@50Hz, 576p@50Hz, 720p@50/60Hz, 1080i@50/60Hz, 1080p@50/60Hz, 4Kx2K @24/25/30Hz
Network Cable	UTP/STP Cat5/5e/6
Transmission distance	Up to 120 meters transmission distance for 1080p 60Hz Full HD over single CAT6
IR signal	Supports 20~60KHz IR devices
Working Temperature	0°C ~ 60°C
Power Supply	DC5V/2A
Power Consumption	TX: 5W; RX: 4W
Dimensions	107.3(W)x94(D)x23.7(H)mm*2pcs
Weight	TX:170g RX:167g
Color	Black

Disclaimer

The product name and brand name may be registered trademark of related manufacturers. TM and ® may be omitted on the user manual. The pictures on the user manual are just for reference, and there may be some slight difference with the real products.

We reserve the rights to make changes without further notice to a product or system described herein to improve reliability, function or design.

2.2 Router Connection: By using network router/repeater, realize unlimited extension.

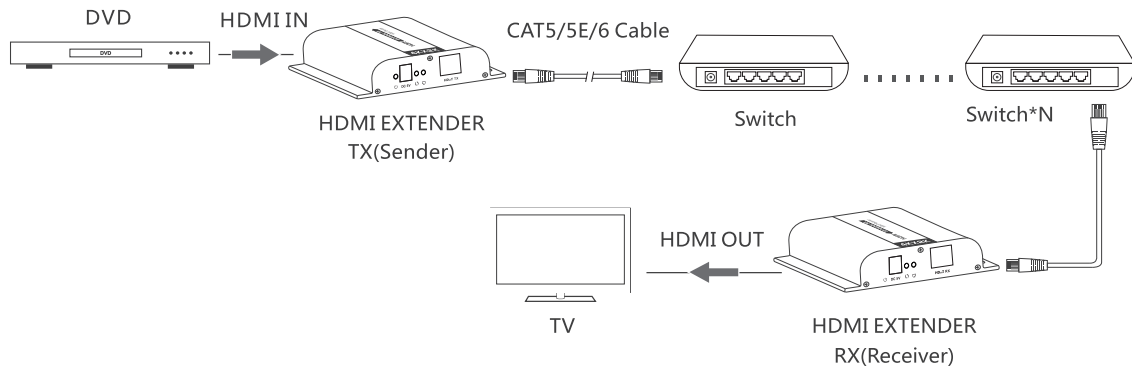

2.3 One-to-many Connection: By using network router/switch, one sender to several receivers, realize extender & splitter function.

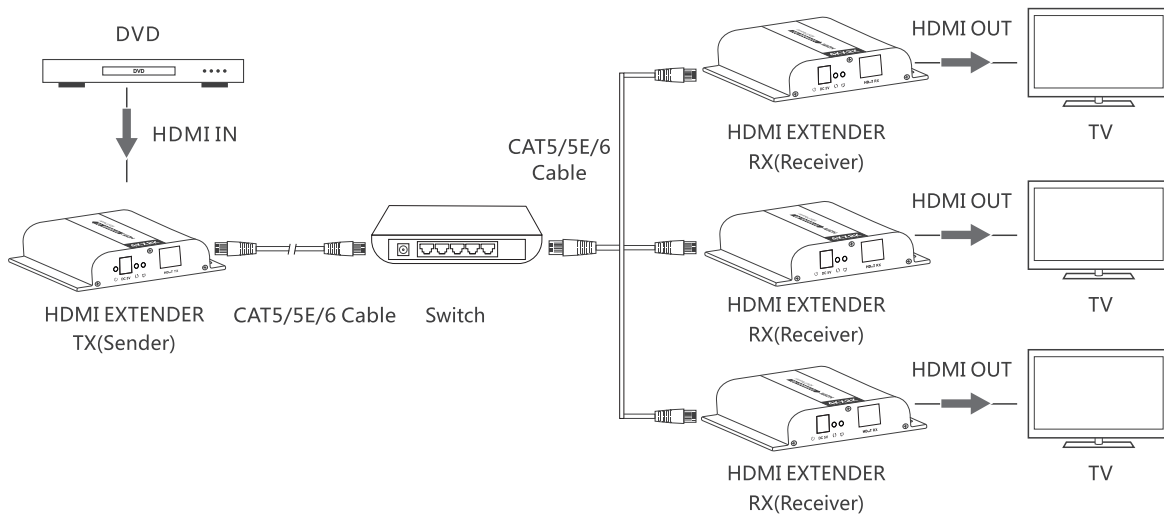

• FAQ

Q: TV display "Waiting for connection" on the right corner?

A: Please check if the power supply of TX (Sender) and switcher (if used) is connected, and make sure connecting cable is firmly.

Q: TV display "Please check the TX input signal" ?

A: 1) please check if there is a HDMI signal input of TX.

2) Try to connect the signal source directly to display device to see if there is signal output from source device or change the signal source, HDMI wire and try again.

Q: When playing 4kx2k source, screen is black without any content?

A: Make sure both TV and HDMI cable support HDMI1.4.